

VOLUME



Heritage

Proudly in business for 35 years, because we've always looked towards the future. Continually evolving, developing, creating space and growing. That's how things have been ever since Lumiparts started selling lighting fittings and products from a home office in Nieuwkoop back in 1985.

We have seen a great deal of change during this time. Especially the increasing importance of

“You only get a true sense of responsibility when you feel properly connected with what you do”

energy management, which was the catalyst for our enthusiastic switch to LED products.

In our opinion, the only way to find out whether any idea is a good one is to tackle it head on. Exploring everything you can possibly do to

exceed customers' expectations. This attitude and approach has seen us grow into an international LED lighting solutions company. Where more than 60 proud professionals are dedicated to getting the best out of themselves and the latest lighting possibilities, every single day.

At our premises in the Netherlands, we work to find you the best solution for your requirements. All the way from design to speedy delivery. We offer an extensive range of LED products, including fittings we've designed, assembled and tested ourselves. We also have an extensive network of suppliers within and outside of Europe through whom we can obtain just about anything.

With always up-to-date knowledge, we continually innovate and learn from each other. So that you can rely on Lumiparts as your trusted LED lighting partner. We've already been doing that for 35 years. And will continue for as long as buildings need lighting...



Sven de Leeuw

member of the [Lumiparts](#) team



Raymond Berg
member of the R&D team



R&D

At Lumiparts, we're always looking for where we can make a difference for our customers. And that's not just something we say. We really do this in practice. After all, light is about experience. And everyone's experience of light

In order to provide you with stylish, energy-efficient LED fittings that we design, produce and assemble to your specifications. Extensively tested against all applicable standards for heat and light output.

“Raising the bar in product development”

is a little different. Every lighting requirement therefore calls for a unique approach.

To facilitate this, our Research & Development department delves deep into innovations, lighting trends and production processes. We draw inspiration from all over the world to delight you with new and improved materials and LED-related technologies.

Want to know how can we make the difference to your project? At Lumiparts, we know that seeing is believing. We therefore welcome you to come and visit at our LumiLAB in Nieuwkoop, where we simulate lighting arrangements and use our goniophotometer to carry out pure light measurements and tests. Always going one step further for our customers.

Would you like to sell light fittings from our extensive range, or market them under your own name? Maybe have an existing model adjusted to your own requirements? Or even have a fitting custom designed exclusively for you? Just about everything is possible at Lumiparts!

In addition to supplying white label LED lighting products, we can always come up with great ideas for unique fitting designs that are just right for your brand, image or lighting project. Stylish, sleek, cool or modern, we are happy to think along with you.

“Dedicated to meeting all your lighting needs”

Whatever you want or need is our priority. Our designers translate your wishes into original fittings which, naturally, are compliant with all legal guidelines and lighting safety standards. We can also turn your own designs and working drawings into reality.

And if you want us to take care of production, assembly, testing and delivery of your fittings from start to finish, we're happy to do that too. We have all the necessary know-how and facilities, together with an extensive network of suppliers on which you can also rely.

OEM & Whitelabe



Thomas le Clercq
member of the Sales team

el



Kim Vermeer

member of the Customer Care team



Passion

Putting our customers first, enjoying what we do, working together to help our business grow and sharing celebrations of success.

There's nothing we love more at Lumiparts. That's why we focus all our energy and expertise on furthering our customers' interests and establishing pleasant working relationships. Because we are only satisfied when you are.

We make it our business to know all there is to know about developments in our industry, so we can share knowledge and experience and demonstrate passion in everything we do. In line with our belief that we all achieve more by working together.

The success of Lumiparts is down to our close knit team. Every one of whom is driven by their love of the profession and of our products. Colleagues who all share their enthusiasm and drive to explore every possibility to its limit.

**“We love
brightening
your day”**

This is how we exceed expectations. Time and time again. There's nothing better for fuelling us with the energy to get the best out of ourselves. For you, and for your customers.

“Expect more from Lumiparts”

We leave nothing to chance at Lumiparts. We never compromise on quality while offering competitive prices and fast delivery. Whatever we do, we do well. After all, you deserve the best.

Naturally, this gives us responsibilities. We realise that all too well. And we fulfil these by only supplying energy-efficient LED lighting products that provide high quality light over a long lifespan, while requiring minimal maintenance. We always stringently check that the products we deliver meet the necessary quality levels.

Along with all this, we are very aware of the need to be critical of ourselves. Always asking what we can do even better when it comes to guaranteeing the reliability of our products and services and exceeding your expectations.

We are therefore continuously working on optimising our business processes. From purchasing to production, from assembly to delivery. Can something be smarter or more efficient? If so, we happily make adjustments to our products and working methods.

Right away.

Quality & Production



Ruud Huijsmans
member of the *Production* team

ion



Sam Zimmerman

*member of the **Purchase** team*



Innovation

At Lumiparts we love to innovate. Accelerating and excelling wherever we can. We are better than anyone at keeping on top of innovations in the lighting products industry. For every customer request, we'll figure out a solution.

“If there’s a way you can do it better, do it”

“Impossible” is not in our vocabulary. That is why we are happy to look at developments and possibilities together with our business associates. As well as exploring what added value we can deliver, on all fronts.

Meeting regularly with each other puts us in a better position to translate customers' and business partners' needs into better and more innovative solutions. This is how we identify opportunities and solve problems. Refreshing and improving existing small and large-scale lighting products, as well as establishing better processes.

This occasionally leads us to unexpectedly discovering something new while we were looking for something else entirely. We believe this isn't just down to chance, but is a direct consequence of our ambition and ability to truly realise ideas together through our knowledge, experience and open minded attitude.

Recessed

Page 016 - 091

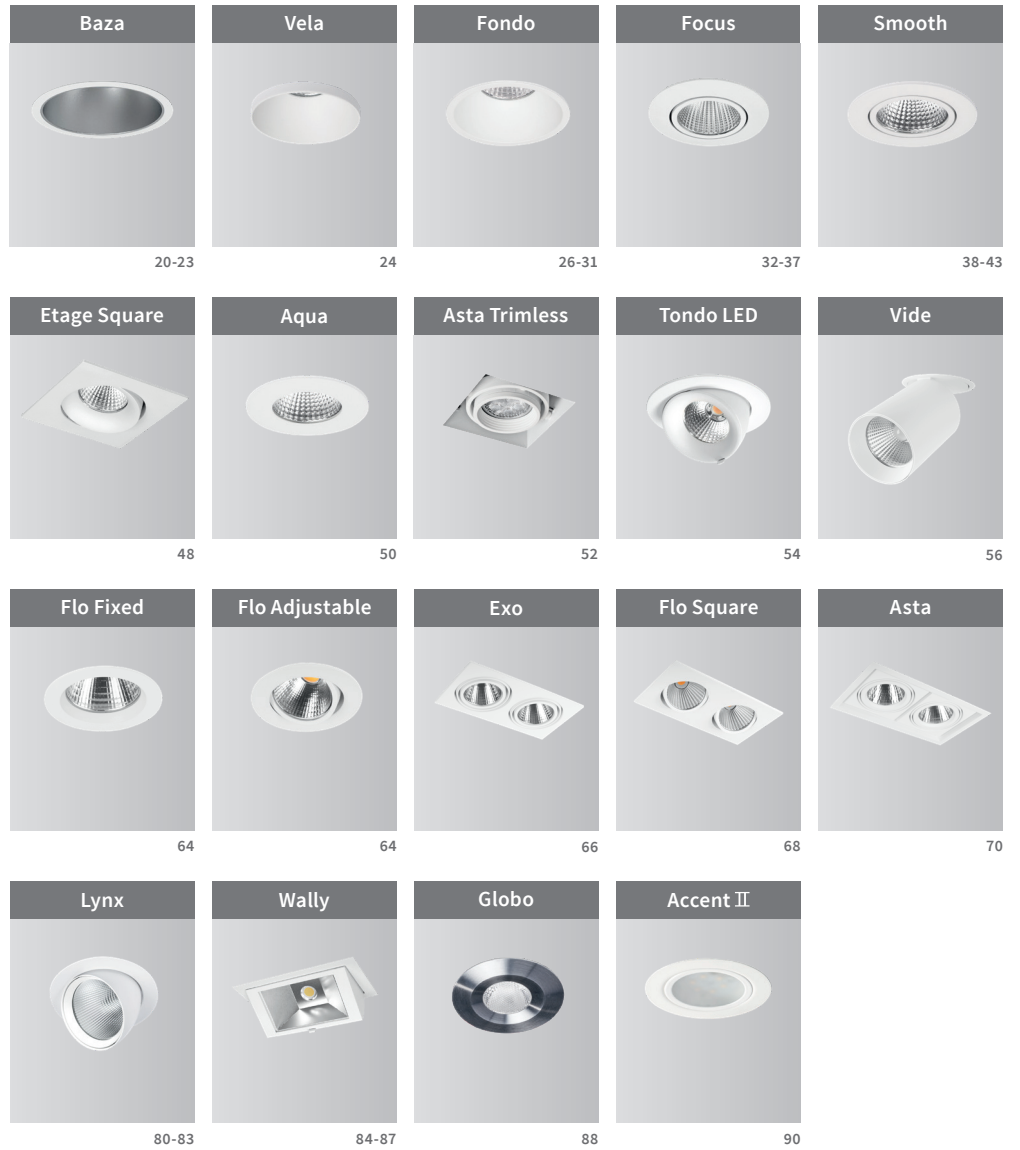

Recessed Panels



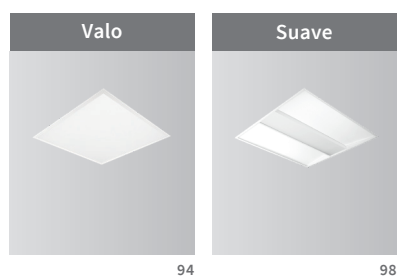

Page 092 - 099

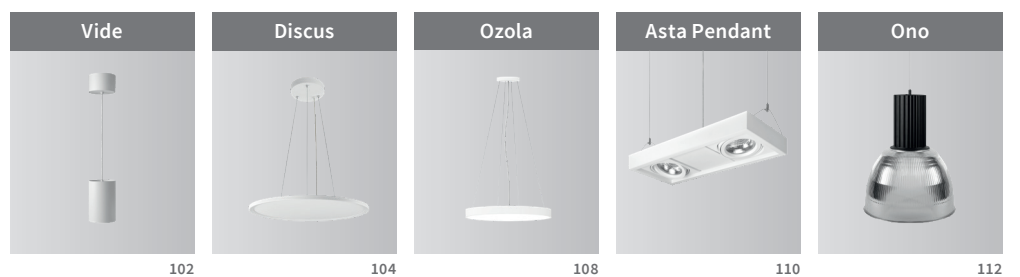

Pendants

Page 100 - 113

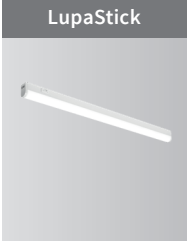

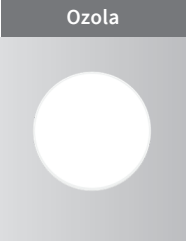
Galex II  116	Galex II  118	Vide  120-123	Caja  124	Sarok  128	Surface Page 114 - 141	
LupaStick  130	Kani  132	Latus  134	Cubit  136	Ozola  138	LED Line Millo  140	

Sintra  144	Pinta In-Track  148-153	Pinta  154	Tubo  156-159	Vide  160	Track Systems Page 142 - 191	
Galex II  162	Froxen  164	Floresta  166	Galex II  168	Wally Track  170	Forte  172	Raillux  174-177
Galex II  178	Common II  180	Telescope II  182	3- & 1-Phase Track  184-191			



Recessed





Baza

An extensive series of architectural downlighters for every application. With a high luminaire efficiency.

Because of the various accessories, it can be used in many settings.

The Baza is also available in Tunable White controlled by Dali or Bluedim, enabling the possibility to create Biodynamic lighting a technical method of achieving the biological effects of daylight in an artificial lighting environment.



Baza

Downlight Fixed

Also available



Gloss 60° reflector

White 60° reflector

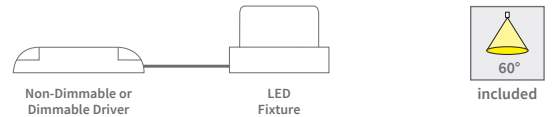

Diameter	110mm						140mm							
Reflector	Matt 60°						Matt 60°							
System Power	8.5W	8.7W	13.6W	14.1W	20.3W	20.7W	9W	8.9W	12.4W	12.3W	18.2W	18W	21.1W	20.8W
CRI	>80Ra						>80Ra							
CCT	3000K	4000K	3000K	4000K	3000K	4000K	3000K	4000K	3000K	4000K	3000K	4000K	3000K	4000K
System Lumen	735lm	766lm	1189lm	1232lm	1620lm	1668lm	921lm	991lm	1387lm	1488lm	1988lm	2128lm	2281lm	2452lm
System Efficacy	86lm/W	88lm/W	87lm/W	87lm/W	79lm/W	80lm/W	102lm/W	111lm/W	111lm/W	121lm/W	109lm/W	118lm/W	108lm/W	118lm/W
Driver	200mA	200mA	350mA	350mA	500mA	500mA	225mA	225mA	350mA	350mA	500mA	500mA	600mA	600mA

Diameter	165mm											
Reflector	Matt 60°											
System Power	9.1W	9.1W	12.7W	13.2W	18.3W	19.2W	21.5W	22.3W	26.2W	27.3W	30.4W	31W
CRI	>80Ra											
CCT	3000K	4000K	3000K	4000K	3000K	4000K	3000K	4000K	3000K	4000K	3000K	4000K
System Lumen	988lm	994lm	1433lm	1441lm	2007lm	2048lm	2319lm	2348lm	2747lm	2781lm	3106lm	3136lm
System Efficacy	108lm/W	109lm/W	113lm/W	109lm/W	110lm/W	107lm/W	108lm/W	105lm/W	105lm/W	102lm/W	102lm/W	101lm/W
Driver	225mA	225mA	350mA	350mA	500mA	500mA	600mA	600mA	700mA	700mA	800mA	800mA

PRODUCT LIST

Article No.	Product Name	Color	System Lumen	CCT	CRI	System Power	Reflector	Cutout size
2.11.4499 / 2.11.4502 ¹	Baza	White	735lm	3000K	>80Ra	8.5W	Matt 60°	Ø 95mm
2.11.4505 / 2.11.4508 ¹	Baza	White	766lm	4000K	>80Ra	8.7W	Matt 60°	Ø 95mm
2.11.4511 / 2.11.4514 ¹	Baza	White	1189lm	3000K	>80Ra	13.6W	Matt 60°	Ø 95mm
2.11.4517 / 2.11.4520 ¹	Baza	White	1232lm	4000K	>80Ra	14.1W	Matt 60°	Ø 95mm
2.11.4523 / 2.11.4526 ¹	Baza	White	1620lm	3000K	>80Ra	20.3W	Matt 60°	Ø 95mm
2.11.4529 / 2.11.4532 ¹	Baza	White	1668lm	4000K	>80Ra	20.7W	Matt 60°	Ø 95mm
2.11.4535 / 2.11.4538 ¹	Baza	White	921lm	3000K	>80Ra	9W	Matt 60°	Ø 125mm
2.11.4541 / 2.11.4544 ¹	Baza	White	991lm	4000K	>80Ra	8.9W	Matt 60°	Ø 125mm
2.11.4547 / 2.11.4550 ¹	Baza	White	1387lm	3000K	>80Ra	12.4W	Matt 60°	Ø 125mm
2.11.4553 / 2.11.4556 ¹	Baza	White	1488lm	4000K	>80Ra	12.3W	Matt 60°	Ø 125mm
2.11.4559 / 2.11.4562 ¹	Baza	White	1988lm	3000K	>80Ra	18.2W	Matt 60°	Ø 125mm
2.11.4565 / 2.11.4568 ¹	Baza	White	2128lm	4000K	>80Ra	18W	Matt 60°	Ø 125mm
2.11.4571 / 2.11.4574 ¹	Baza	White	2281lm	3000K	>80Ra	21.1W	Matt 60°	Ø 125mm
2.11.4577 / 2.11.4580 ¹	Baza	White	2452lm	4000K	>80Ra	20.8W	Matt 60°	Ø 125mm
2.11.4583 / 2.11.4586 ¹	Baza	White	988lm	3000K	>80Ra	9.1W	Matt 60°	Ø 145mm
2.11.4589 / 2.11.4592 ¹	Baza	White	994lm	4000K	>80Ra	9.1W	Matt 60°	Ø 145mm
2.11.4595 / 2.11.4598 ¹	Baza	White	1433lm	3000K	>80Ra	12.7W	Matt 60°	Ø 145mm
2.11.4601 / 2.11.4604 ¹	Baza	White	1441lm	4000K	>80Ra	13.2W	Matt 60°	Ø 145mm
2.11.4607 / 2.11.4610 ¹	Baza	White	2007lm	3000K	>80Ra	18.3W	Matt 60°	Ø 145mm
2.11.4613 / 2.11.4616 ¹	Baza	White	2048lm	4000K	>80Ra	19.2W	Matt 60°	Ø 145mm
2.11.4619 / 2.11.4622 ¹	Baza	White	2319lm	3000K	>80Ra	21.5W	Matt 60°	Ø 145mm
2.11.4625 / 2.11.4628 ¹	Baza	White	2348lm	4000K	>80Ra	22.3W	Matt 60°	Ø 145mm
2.11.4631 / 2.11.4634 ¹	Baza	White	2747lm	3000K	>80Ra	26.2W	Matt 60°	Ø 145mm
2.11.4637 / 2.11.4640 ¹	Baza	White	2781lm	4000K	>80Ra	27.3W	Matt 60°	Ø 145mm
2.11.4643 / 2.11.4646 ¹	Baza	White	3106lm	3000K	>80Ra	30.4W	Matt 60°	Ø 145mm
2.11.4649 / 2.11.4652 ¹	Baza	White	3136lm	4000K	>80Ra	31W	Matt 60°	Ø 145mm

¹ Article No. with ¹ indicates DALI dimmable driver is included.

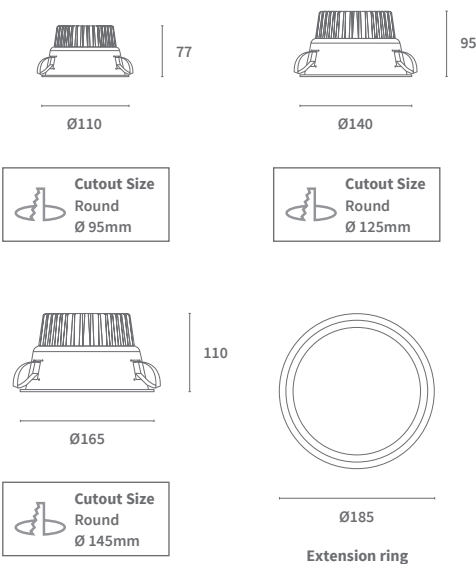

Baza 18.2W 3000K

H [m]	[lux]	Beam [Ø cm]
1	1847	120
2	462	240
3	205	370
4	115	490
5	74	610

Beam (50%) Angle: 61° Field (10%) Angle: 101°

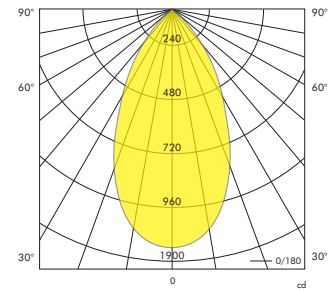

ALSO AVAILABLE

Article No.	Description	Color	Size
2.01.1261	Extension ring for Baza Ø 165mm	White	Ø 185mm
-----	Emergency kit available on request		



Baza

Downlight
Fixed

Also available



Gloss 60° reflector

White 60° reflector

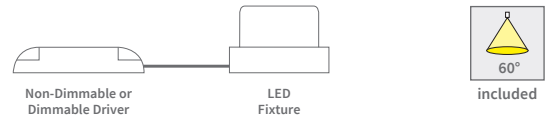

Diameter	190mm											
Reflector	Matt 60°											
System Power	9.1W	9.4W	12.8W	13.1W	18.7W	19.2W	21.5W	22.5W	26.4W	27.6W	30.3W	31.6W
CRI	>80Ra											
CCT	3000K	4000K	3000K	4000K	3000K	4000K	3000K	4000K	3000K	4000K	3000K	4000K
System Lumen	988lm	1034lm	1424lm	1482lm	2024lm	2177lm	2304lm	2442lm	2735lm	2889lm	3106lm	3251lm
System Efficacy	108lm/W	110lm/W	111lm/W	113lm/W	108lm/W	113lm/W	107lm/W	108lm/W	103lm/W	105lm/W	102lm/W	103lm/W
Driver	225mA	225mA	350mA	350mA	500mA	500mA	600mA	600mA	700mA	700mA	800mA	800mA

Diameter	230mm										
Reflector	Matt 60°										
System Power	12.6W	13.1W	18.5W	19.1W	21.6W	22.4W	26.2W	27.3W	30.5W	31.3W	
CRI	>80Ra										
CCT	3000K	4000K	3000K	4000K	3000K	4000K	3000K	4000K	3000K	4000K	
System Lumen	1508lm	1542lm	2139lm	2175lm	2461lm	2509lm	2916lm	2976lm	3322lm	3497lm	
System Efficacy	120lm/W	118lm/W	116lm/W	114lm/W	114lm/W	112lm/W	111lm/W	109lm/W	109lm/W	112lm/W	
Driver	350mA	350mA	500mA	500mA	600mA	600mA	700mA	700mA	800mA	800mA	

PRODUCT LIST

Article No.	Product Name	Color	System Lumen	CCT	CRI	System Power	Reflector	Cutout size
2.11.4655 / 2.11.4658 ¹	Baza	White	988lm	3000K	>80Ra	9.1W	Matt 60°	Ø 165mm
2.11.4661 / 2.11.4664 ¹	Baza	White	1034lm	4000K	>80Ra	9.4W	Matt 60°	Ø 165mm
2.11.4667 / 2.11.4670 ¹	Baza	White	1424lm	3000K	>80Ra	12.8W	Matt 60°	Ø 165mm
2.11.4673 / 2.11.4676 ¹	Baza	White	1482lm	4000K	>80Ra	13.1W	Matt 60°	Ø 165mm
2.11.4679 / 2.11.4682 ¹	Baza	White	2024lm	3000K	>80Ra	18.7W	Matt 60°	Ø 165mm
2.11.4685 / 2.11.4688 ¹	Baza	White	2117lm	4000K	>80Ra	19.2W	Matt 60°	Ø 165mm
2.11.4691 / 2.11.4694 ¹	Baza	White	2304lm	3000K	>80Ra	21.5W	Matt 60°	Ø 165mm
2.11.4697 / 2.11.4700 ¹	Baza	White	2442lm	4000K	>80Ra	22.5W	Matt 60°	Ø 165mm
2.11.4703 / 2.11.4706 ¹	Baza	White	2735lm	3000K	>80Ra	26.4W	Matt 60°	Ø 165mm
2.11.4709 / 2.11.4712 ¹	Baza	White	2889lm	4000K	>80Ra	27.6W	Matt 60°	Ø 165mm
2.11.4715 / 2.11.4718 ¹	Baza	White	3106lm	3000K	>80Ra	30.3W	Matt 60°	Ø 165mm
2.11.4721 / 2.11.4724 ¹	Baza	White	3251lm	4000K	>80Ra	31.6W	Matt 60°	Ø 165mm
2.11.4727 / 2.11.4730 ¹	Baza	White	1508lm	3000K	>80Ra	12.6W	Matt 60°	Ø 210mm
2.11.4733 / 2.11.4736 ¹	Baza	White	1542lm	4000K	>80Ra	13.1W	Matt 60°	Ø 210mm
2.11.4739 / 2.11.4742 ¹	Baza	White	2139lm	3000K	>80Ra	18.5W	Matt 60°	Ø 210mm
2.11.4745 / 2.11.4748 ¹	Baza	White	2175lm	4000K	>80Ra	19.1W	Matt 60°	Ø 210mm
2.11.4751 / 2.11.4754 ¹	Baza	White	2461lm	3000K	>80Ra	21.6W	Matt 60°	Ø 210mm
2.11.4757 / 2.11.4760 ¹	Baza	White	2509lm	4000K	>80Ra	22.4W	Matt 60°	Ø 210mm
2.11.4763 / 2.11.4766 ¹	Baza	White	2916lm	3000K	>80Ra	26.2W	Matt 60°	Ø 210mm
2.11.4769 / 2.11.4772 ¹	Baza	White	2976lm	4000K	>80Ra	27.3W	Matt 60°	Ø 210mm
2.11.4775 / 2.11.4778 ¹	Baza	White	3322lm	3000K	>80Ra	30.5W	Matt 60°	Ø 210mm
2.11.4781 / 2.11.4784 ¹	Baza	White	3497lm	4000K	>80Ra	31.3W	Matt 60°	Ø 210mm

¹ Article No. with ¹ indicates DALI dimmable driver is included.

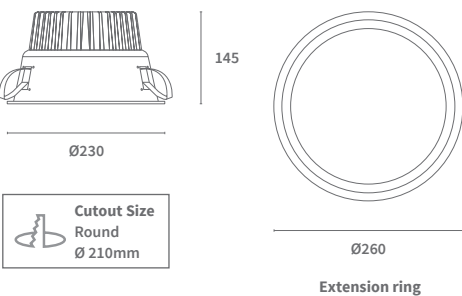
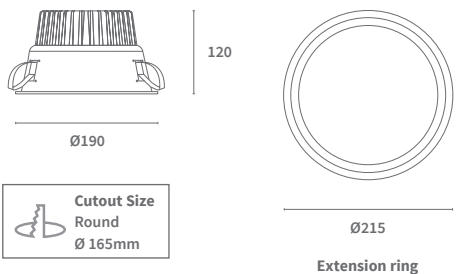

ALSO AVAILABLE

Article No.	Description	Color	Size
2.01.1262	Extension ring for Baza Ø 190mm	White	Ø 215mm
2.01.1263	Extension ring for Baza Ø 230mm	White	Ø 260mm
-----	Emergency kit available on request		



Vela

Spot Light Round Fixed

Also available

6W - 350mA



System Power	12W		
CRI	>90Ra		
CCT	2700K	3000K	4000K
LED Lumen	650lm	700lm	800lm
LED Efficacy	72lm/W	78lm/W	89lm/W
LOR	81%		
Driver	500mA Non-Dimmable or Dimmable Driver (included)		

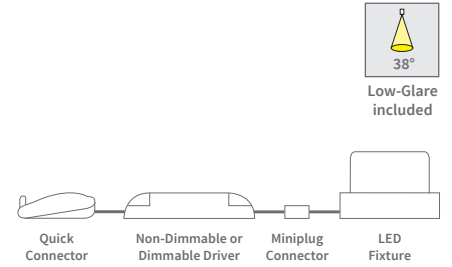

Vela 12W 3000K

H [m]	[lux]	Beam [Ø cm]	Field [Ø cm]
1	1044	70	140
2	261	140	290
3	116	210	430
4	65	280	580
5	42	350	720

Beam (50%) Angle: 38°

Field (10%) Angle: 72°

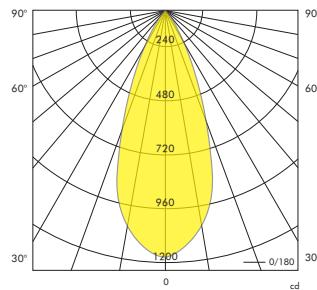

PRODUCT LIST

Article No.	Product Name	Color	LED Lumen	CCT	CRI	LED Power	Reflector	Cutout size
2.11.1957 / 2.11.1958 ¹	Vela	Grey	650lm	2700K	>90Ra	9W	38°	Ø 75mm
2.11.1963 / 2.11.1964 ¹	Vela	White	650lm	2700K	>90Ra	9W	38°	Ø 75mm
2.11.1969 / 2.11.1970 ¹	Vela	Black	650lm	2700K	>90Ra	9W	38°	Ø 75mm
2.11.1959 / 2.11.1960 ¹	Vela	Grey	700lm	3000K	>90Ra	9W	38°	Ø 75mm
2.11.1965 / 2.11.1966 ¹	Vela	White	700lm	3000K	>90Ra	9W	38°	Ø 75mm
2.11.1971 / 2.11.1972 ¹	Vela	Black	700lm	3000K	>90Ra	9W	38°	Ø 75mm
2.11.1961 / 2.11.1962 ¹	Vela	Grey	800lm	4000K	>90Ra	9W	38°	Ø 75mm
2.11.1967 / 2.11.1968 ¹	Vela	White	800lm	4000K	>90Ra	9W	38°	Ø 75mm
2.11.1973 / 2.11.1974 ¹	Vela	Black	800lm	4000K	>90Ra	9W	38°	Ø 75mm

¹ Article number with ¹ indicates dimmable driver is included.

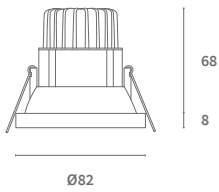

ALSO AVAILABLE

Article No.	Description
-----	6W - 350mA version available on request

AVAILABLE DRIVERS

Article No.	Description
-----	DALI Dimmable driver
-----	1-10V Dimmable driver



Fondo

Spot Light

Round Fixed & Adjustable

Also available

6W - 350mA

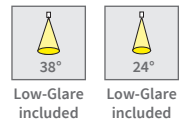

System Power	12W		
CRI	>90Ra		
CCT	2700K	3000K	4000K
LED Lumen	650lm	700lm	800lm
LED Efficacy	72lm/W	78lm/W	89lm/W
LOR	Up to 81%		
Driver	500mA Non-Dimmable or Dimmable Driver (included)		

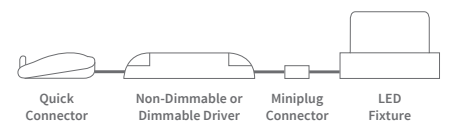

Fondo Round Fixed 12W 3000K

H [m]	[lux]	Beam [Ø cm]	Field [Ø cm]
1	1044	70	140
2	261	140	290
3	116	210	430
4	65	280	580
5	42	350	720

Beam (50%) Angle: 38°

Field (10%) Angle: 72°

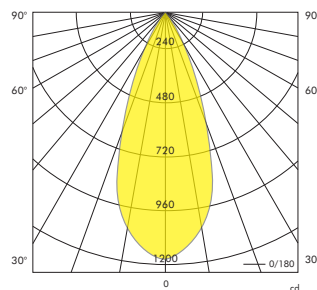

PRODUCT LIST

Article No.	Product Name	Color	LED Lumen	CCT	CRI	LED Power	Reflector	Cutout size
2.11.1849 / 2.11.1850 ¹	Fondo Fixed	Grey	650lm	2700K	>90Ra	9W	38°	Ø 70mm
2.11.1855 / 2.11.1856 ¹	Fondo Fixed	White	650lm	2700K	>90Ra	9W	38°	Ø 70mm
2.11.1861 / 2.11.1862 ¹	Fondo Fixed	Black	650lm	2700K	>90Ra	9W	38°	Ø 70mm
2.11.1851 / 2.11.1852 ¹	Fondo Fixed	Grey	700lm	3000K	>90Ra	9W	38°	Ø 70mm
2.11.1857 / 2.11.1858 ¹	Fondo Fixed	White	700lm	3000K	>90Ra	9W	38°	Ø 70mm
2.11.1863 / 2.11.1864 ¹	Fondo Fixed	Black	700lm	3000K	>90Ra	9W	38°	Ø 70mm
2.11.1853 / 2.11.1854 ¹	Fondo Fixed	Grey	800lm	4000K	>90Ra	9W	38°	Ø 70mm
2.11.1859 / 2.11.1860 ¹	Fondo Fixed	White	800lm	4000K	>90Ra	9W	38°	Ø 70mm
2.11.1865 / 2.11.1866 ¹	Fondo Fixed	Black	800lm	4000K	>90Ra	9W	38°	Ø 70mm

¹ Article No. with ¹ indicates dimmable driver is included.

PRODUCT LIST

Article No.	Product Name	Color	LED Lumen	CCT	CRI	LED Power	Reflector	Cutout size
2.11.1831 / 2.11.1832 ¹	Fondo Adjustable	Grey	650lm	2700K	>90Ra	9W	24°	Ø 70mm
2.11.1837 / 2.11.1838 ¹	Fondo Adjustable	White	650lm	2700K	>90Ra	9W	24°	Ø 70mm
2.11.1843 / 2.11.1844 ¹	Fondo Adjustable	Black	650lm	2700K	>90Ra	9W	24°	Ø 70mm
2.11.1833 / 2.11.1834 ¹	Fondo Adjustable	Grey	700lm	3000K	>90Ra	9W	24°	Ø 70mm
2.11.1839 / 2.11.1840 ¹	Fondo Adjustable	White	700lm	3000K	>90Ra	9W	24°	Ø 70mm
2.11.1845 / 2.11.1846 ¹	Fondo Adjustable	Black	700lm	3000K	>90Ra	9W	24°	Ø 70mm
2.11.1835 / 2.11.1836 ¹	Fondo Adjustable	Grey	800lm	4000K	>90Ra	9W	24°	Ø 70mm
2.11.1841 / 2.11.1842 ¹	Fondo Adjustable	White	800lm	4000K	>90Ra	9W	24°	Ø 70mm
2.11.1847 / 2.11.1848 ¹	Fondo Adjustable	Black	800lm	4000K	>90Ra	9W	24°	Ø 70mm

¹ Article No. with ¹ indicates dimmable driver is included.

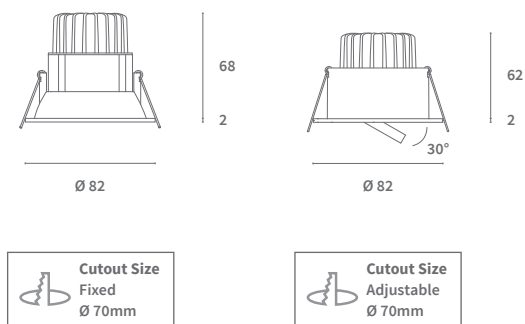

Fondo Round Adjustable 12W 3000K

H [m]	[lux]	Beam [Ø cm]	Field [Ø cm]
1	2625	40	90
2	656	80	190
3	292	120	280
4	164	160	370
5	105	190	460

Beam (50%) Angle: 22° Field (10%) Angle: 49°

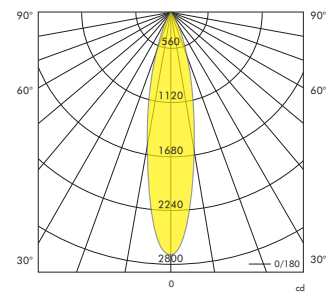

ALSO AVAILABLE

Article No.	Description
-----	6W - 350mA version available on request

AVAILABLE DRIVERS

Article No.	Description
-----	DALI Dimmable driver
-----	1-10V Dimmable driver



Fondo Asymmetrical

Spot Light
Round Fixed

Also available

6W - 350mA



Low-Glare
included

System Power	12W		
CRI	>90Ra		
CCT	2700K	3000K	4000K
LED Lumen	650lm	700lm	800lm
LED Efficacy	72lm/W	78lm/W	89lm/W
LOR	Up to 75%		
Driver	500mA Non-Dimmable or Dimmable Driver (included)		

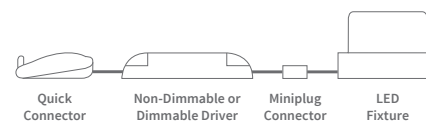

Fondo Asymmetrical Round 12W 3000K

H [m]	[lux]	Beam [Ø cm]	Field [Ø cm]
1	1647	40	100
2	412	80	200
3	183	120	300
4	103	160	400
5	66	200	500

Beam (50%) Angle: 23°

Field (10%) Angle: 53°

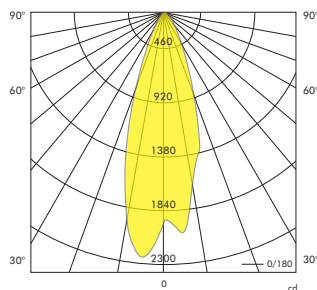

PRODUCT LIST

Article No.	Product Name	Color	LED Lumen	CCT	CRI	LED Power	Reflector	Cutout size
2.11.1873 / 2.11.1874 ¹	Fondo Asymmetrical Round	White	650lm	2700K	>90Ra	9W	20°	Ø 83mm
2.11.1879 / 2.11.1880 ¹	Fondo Asymmetrical Round	Black	650lm	2700K	>90Ra	9W	20°	Ø 83mm
2.11.1875 / 2.11.1876 ¹	Fondo Asymmetrical Round	White	700lm	3000K	>90Ra	9W	20°	Ø 83mm
2.11.1881 / 2.11.1882 ¹	Fondo Asymmetrical Round	Black	700lm	3000K	>90Ra	9W	20°	Ø 83mm
2.11.1877 / 2.11.1878 ¹	Fondo Asymmetrical Round	White	800lm	4000K	>90Ra	9W	20°	Ø 83mm
2.11.1883 / 2.11.1884 ¹	Fondo Asymmetrical Round	Black	800lm	4000K	>90Ra	9W	20°	Ø 83mm

¹Article No. with ¹ indicates dimmable driver is included.

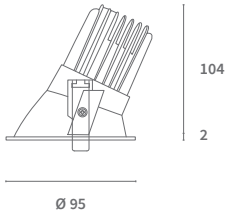

ALSO AVAILABLE

Article No.	Description
-----	6W - 350mA version available on request

AVAILABLE DRIVERS

Article No.	Description
-----	DALI Dimmable driver
-----	1-10V Dimmable driver



Fondo Asymmetrical

Spot Light
Square Fixed

Also available

6W - 350mA



Low-Glare included

System Power	12W		
CRI	>90Ra		
CCT	2700K	3000K	4000K
LED Lumen	650lm	700lm	800lm
LED Efficacy	72lm/W	78lm/W	89lm/W
LOR	Up to 75%		
Driver	500mA Non-Dimmable or Dimmable Driver (included)		

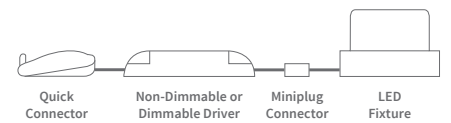

Fondo Asymmetrical Square 12W 3000K

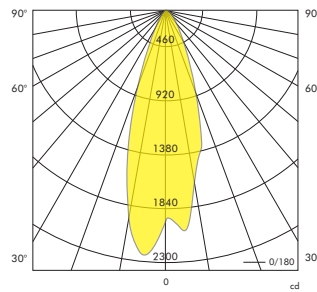
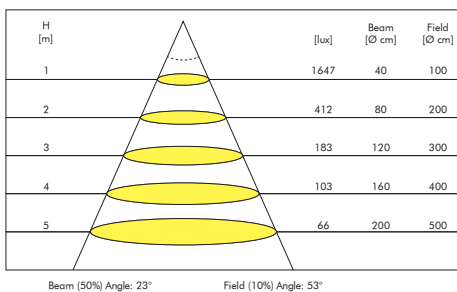

PRODUCT LIST

Article No.	Product Name	Color	LED Lumen	CCT	CRI	LED Power	Reflector	Cutout size
2.11.1891 / 2.11.1892 ¹	Fondo Asymmetrical Square	White	650lm	2700K	>90Ra	9W	20°	86 x 83mm
2.11.1897 / 2.11.1898 ¹	Fondo Asymmetrical Square	Black	650lm	2700K	>90Ra	9W	20°	86 x 83mm
2.11.1893 / 2.11.1894 ¹	Fondo Asymmetrical Square	White	700lm	3000K	>90Ra	9W	20°	86 x 83mm
2.11.1899 / 2.11.1900 ¹	Fondo Asymmetrical Square	Black	700lm	3000K	>90Ra	9W	20°	86 x 83mm
2.11.1895 / 2.11.1896 ¹	Fondo Asymmetrical Square	White	800lm	4000K	>90Ra	9W	20°	86 x 83mm
2.11.1901 / 2.11.1902 ¹	Fondo Asymmetrical Square	Black	800lm	4000K	>90Ra	9W	20°	86 x 83mm

¹Article No. with ¹ indicates dimmable driver is included.

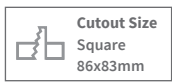
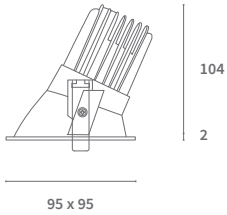

ALSO AVAILABLE

Article No.	Description
-----	6W - 350mA version available on request

AVAILABLE DRIVERS

Article No.	Description
-----	DALI Dimmable driver
-----	1-10V Dimmable driver



Focus

Spot Light

Deep Adjustable



System Power	8.4W	
CRI	>90Ra	
CCT	2700K	3000K
LED Lumen	520lm	550lm
LED Efficacy	84lm/W	89lm/W
LOR	>80%	
Driver	Non-Dimmable or Dimmable Driver (included)	

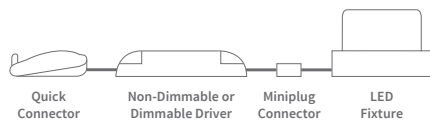

Focus 8.4W 3000K

H [m]	[lux]	Beam [Ø cm]	Field [Ø cm]
1	863	70	180
2	216	140	360
3	96	210	550
4	54	280	730
5	35	350	910

Beam (50%) Angle: 38° Field (10%) Angle: 84°

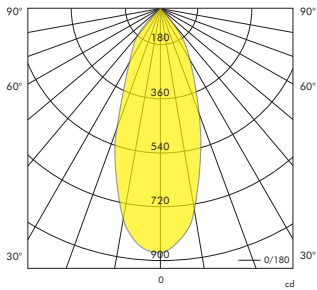

PRODUCT LIST

Article No.	Product Name	Color	LED Lumen	CCT	CRI	LED Power	Reflector	Cutout size
2.11.3144 / 2.11.3145 ¹	Focus Deep Adjustable	Chrome	520lm	2700K	>90Ra	6W	38°	Ø 75mm
2.11.3147 / 2.11.3148 ¹	Focus Deep Adjustable	Brushed Alu.	520lm	2700K	>90Ra	6W	38°	Ø 75mm
2.11.3150 / 2.11.3151 ¹	Focus Deep Adjustable	Sandy White	520lm	2700K	>90Ra	6W	38°	Ø 75mm
2.11.3153 / 2.11.3154 ¹	Focus Deep Adjustable	Chrome	550lm	3000K	>90Ra	6W	38°	Ø 75mm
2.11.3156 / 2.11.3157 ¹	Focus Deep Adjustable	Brushed Alu.	550lm	3000K	>90Ra	6W	38°	Ø 75mm
2.11.3159 / 2.11.3160 ¹	Focus Deep Adjustable	Sandy White	550lm	3000K	>90Ra	6W	38°	Ø 75mm

¹Article No. with ¹ indicates dimmable driver is included.

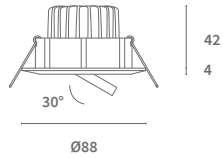

AVAILABLE DRIVERS

Article No.	Description
-----	DALI Dimmable Driver
-----	1-10V Dimmable Driver



Focus

Spot Light

Fixed & Adjustable



System Power	16W		
CRI	>90Ra		
CCT	2700K	3000K	4000K
LED Lumen	1210lm	1320lm	1490lm
LED Efficacy	93lm/W	102lm/W	115lm/W
LOR	Up to 90%		
Driver	Non-Dimmable or Dimmable Driver (included)		

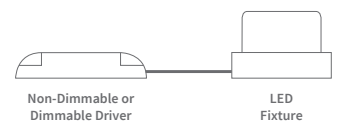

Focus 16W 3000K

H [m]	[lux]	Beam [Ø cm]	Field [Ø cm]
1	1824	60	180
2	456	120	360
3	203	180	530
4	114	240	710
5	73	300	890

Beam (50%) Angle: 33° Field (10%) Angle: 83°

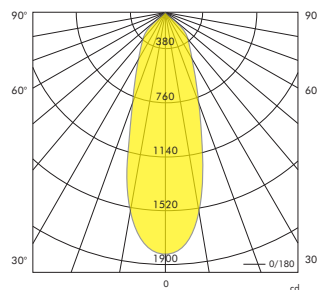

PRODUCT LIST

Article No.	Product Name	Color	LED Lumen	CCT	CRI	LED Power	Reflector	Cutout size
2.11.4219 / 2.11.1424 ¹	Focus Fixed	Chrome	1210lm	2700K	>90Ra	13W	32°	Ø 65mm
2.11.4220 / 2.11.1425 ¹	Focus Fixed	Brushed Alu.	1210lm	2700K	>90Ra	13W	32°	Ø 65mm
2.11.4221 / 2.11.1426 ¹	Focus Fixed	Sandy White	1210lm	2700K	>90Ra	13W	32°	Ø 65mm
2.11.4222 / 2.11.1427 ¹	Focus Fixed	Black	1210lm	2700K	>90Ra	13W	32°	Ø 65mm
2.11.4223 / 2.11.1428 ¹	Focus Fixed	Chrome	1320lm	3000K	>90Ra	13W	32°	Ø 65mm
2.11.4224 / 2.11.1429 ¹	Focus Fixed	Brushed Alu.	1320lm	3000K	>90Ra	13W	32°	Ø 65mm
2.11.4225 / 2.11.1430 ¹	Focus Fixed	Sandy White	1320lm	3000K	>90Ra	13W	32°	Ø 65mm
2.11.4226 / 2.11.1431 ¹	Focus Fixed	Black	1320lm	3000K	>90Ra	13W	32°	Ø 65mm
2.11.4227 / 2.11.1432 ¹	Focus Fixed	Chrome	1490lm	4000K	>90Ra	13W	32°	Ø 65mm
2.11.4228 / 2.11.1433 ¹	Focus Fixed	Brushed Alu.	1490lm	4000K	>90Ra	13W	32°	Ø 65mm
2.11.4229 / 2.11.1434 ¹	Focus Fixed	Sandy White	1490lm	4000K	>90Ra	13W	32°	Ø 65mm
2.11.4230 / 2.11.1435 ¹	Focus Fixed	Black	1490lm	4000K	>90Ra	13W	32°	Ø 65mm

PRODUCT LIST

Article No.	Product Name	Color	LED Lumen	CCT	CRI	LED Power	Reflector	Cutout size
2.11.4231 / 2.11.1436 ¹	Focus Adjustable	Chrome	1210lm	2700K	>90Ra	13W	32°	Ø 75mm
2.11.4096 / 2.11.1437 ¹	Focus Adjustable	Brushed Alu.	1210lm	2700K	>90Ra	13W	32°	Ø 75mm
2.11.4097 / 2.11.1438 ¹	Focus Adjustable	Sandy White	1210lm	2700K	>90Ra	13W	32°	Ø 75mm
2.11.4098 / 2.11.1439 ¹	Focus Adjustable	Black	1210lm	2700K	>90Ra	13W	32°	Ø 75mm
2.11.4232 / 2.11.1440 ¹	Focus Adjustable	Chrome	1320lm	3000K	>90Ra	13W	32°	Ø 75mm
2.11.4099 / 2.11.1441 ¹	Focus Adjustable	Brushed Alu.	1320lm	3000K	>90Ra	13W	32°	Ø 75mm
2.11.4100 / 2.11.1442 ¹	Focus Adjustable	Sandy White	1320lm	3000K	>90Ra	13W	32°	Ø 75mm
2.11.4101 / 2.11.1443 ¹	Focus Adjustable	Black	1320lm	3000K	>90Ra	13W	32°	Ø 75mm
2.11.4233 / 2.11.1444 ¹	Focus Adjustable	Chrome	1490lm	4000K	>90Ra	13W	32°	Ø 75mm
2.11.4102 / 2.11.1445 ¹	Focus Adjustable	Brushed Alu.	1490lm	4000K	>90Ra	13W	32°	Ø 75mm
2.11.4234 / 2.11.1446 ¹	Focus Adjustable	Sandy White	1490lm	4000K	>90Ra	13W	32°	Ø 75mm
2.11.4103 / 2.11.1447 ¹	Focus Adjustable	Black	1490lm	4000K	>90Ra	13W	32°	Ø 75mm

¹ Article No. with ¹ indicates dimmable driver is included.

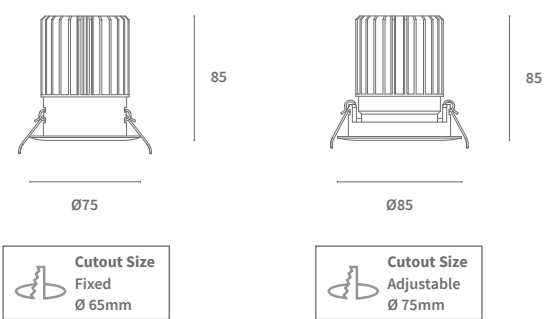

AVAILABLE BEAM ANGLES

Article No.	Description
2.01.0697	Reflector 24° for Focus Fixed / Adjustable
2.01.0699	Reflector 50° for Focus Fixed / Adjustable

AVAILABLE DRIVERS

Article No.	Description
-----	DALI Dimmable driver
-----	1-10V Dimmable driver



Focus

Spot Light

Adjustable



System Power	22W		
CRI	>90Ra		
CCT	2700K	3000K	4000K
LED Lumen	1640lm	1750lm	1860lm
LED Efficacy	86lm/W	92lm/W	98lm/W
LOR	Up to 90%		
Driver	Non-Dimmable or Dimmable Driver (included)		
	Leading Edge / Trailing Edge / 1-10V		

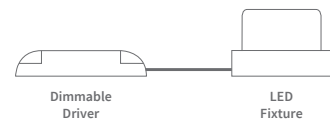

Focus 22W 3000K

H [m]	[lux]	Beam [Ø cm]	Field [Ø cm]
1	3418	50	120
2	855	110	250
3	380	160	370
4	214	220	500
5	137	270	620

Beam (50%) Angle: 30° Field (10%) Angle: 64°

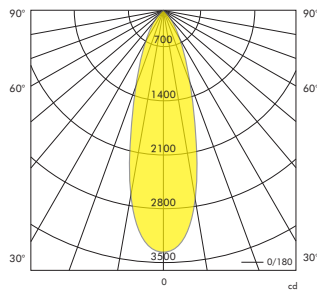

PRODUCT LIST

Article No.	Product Name	Color	LED Lumen	CCT	CRI	LED Power	Reflector	Cutout size
2.11.4235 / 2.11.1448 ¹	Focus Adjustable	Chrome	1640lm	2700K	>90Ra	19W	30°	Ø 90mm
2.11.4106 / 2.11.1449 ¹	Focus Adjustable	Brushed Alu.	1640lm	2700K	>90Ra	19W	30°	Ø 90mm
2.11.4107 / 2.11.1450 ¹	Focus Adjustable	Sandy White	1640lm	2700K	>90Ra	19W	30°	Ø 90mm
2.11.4108 / 2.11.1451 ¹	Focus Adjustable	Black	1640lm	2700K	>90Ra	19W	30°	Ø 90mm
2.11.4236 / 2.11.1452 ¹	Focus Adjustable	Chrome	1750lm	3000K	>90Ra	19W	30°	Ø 90mm
2.11.4109 / 2.11.1453 ¹	Focus Adjustable	Brushed Alu.	1750lm	3000K	>90Ra	19W	30°	Ø 90mm
2.11.4110 / 2.11.1454 ¹	Focus Adjustable	Sandy White	1750lm	3000K	>90Ra	19W	30°	Ø 90mm
2.11.4111 / 2.11.1455 ¹	Focus Adjustable	Black	1750lm	3000K	>90Ra	19W	30°	Ø 90mm
2.11.4237 / 2.11.1456 ¹	Focus Adjustable	Chrome	1860lm	4000K	>90Ra	19W	30°	Ø 90mm
2.11.4112 / 2.11.1457 ¹	Focus Adjustable	Brushed Alu.	1860lm	4000K	>90Ra	19W	30°	Ø 90mm
2.11.4113 / 2.11.1458 ¹	Focus Adjustable	Sandy White	1860lm	4000K	>90Ra	19W	30°	Ø 90mm
2.11.4114 / 2.11.1459 ¹	Focus Adjustable	Black	1860lm	4000K	>90Ra	19W	30°	Ø 90mm

¹Article No. with ¹ indicates dimmable driver is included.

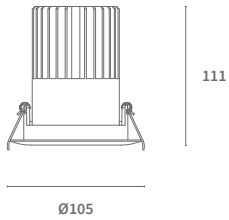

AVAILABLE BEAM ANGLES

Article No.	Description
2.01.0700	Reflector 16° for Focus Adjustable

AVAILABLE DRIVERS

Article No.	Description
-----	DALI Dimmable driver



Smooth

Spot Light

Adjustable Round Deep



System Power	8.4W	
CRI	>90Ra	
CCT	2700K	3000K
LED Lumen	520lm	550lm
LED Efficacy	86lm/W	91lm/W
LOR	>70%	
Driver	Non-Dimmable or Dimmable Driver (included)	

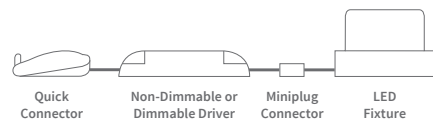

Smooth 8.4W 3000K

H [m]	[lux]	Beam [Ø cm]	Field [Ø cm]
1	919	68	128
2	230	137	257
3	102	205	385
4	58	273	513
5	37	341	642

Beam (50%) Angle: 38° Field (10%) Angle: 65°

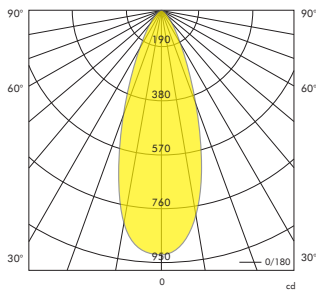

PRODUCT LIST

Article No.	Product Name	Color	LED Lumen	CCT	CRI	LED Power	Reflector	Cutout size
2.11.3162 / 2.11.3163 ¹	Smooth Adjustable Round Deep Reflector	Aluminium	520lm	2700K	>90Ra	6W	38°	Ø 68mm
2.11.3165 / 2.11.3166 ¹	Smooth Adjustable Round Deep Reflector	Sandy White	520lm	2700K	>90Ra	6W	38°	Ø 68mm
2.11.3168 / 2.11.3169 ¹	Smooth Adjustable Round Deep Reflector	Aluminium	550lm	3000K	>90Ra	6W	38°	Ø 68mm
2.11.3171 / 2.11.3172 ¹	Smooth Adjustable Round Deep Reflector	Sandy White	550lm	3000K	>90Ra	6W	38°	Ø 68mm

¹ Article No. with ¹ indicates dimmable driver is included.

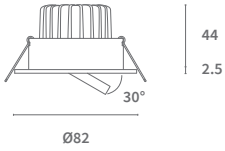

AVAILABLE DRIVERS

Article No.	Description
-----	DALI Dimmable driver
-----	1-10V Dimmable driver



Smooth

Spot Light

Adjustable Round Deep



System Power	8.4W	
CRI	>90Ra	
CCT	2700K	3000K
LED Lumen	520lm	550lm
LED Efficacy	84lm/W	89lm/W
LOR	>70%	
Driver	350mA Non-Dimmable or Dimmable Driver (included)	

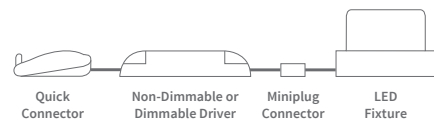

Smooth 8.4W 3000K

H [m]	[lux]	Beam [Ø cm]	Field [Ø cm]
1	919	68	128
2	230	137	257
3	102	205	385
4	58	273	513
5	37	341	642

Beam (50%) Angle: 38° Field (10%) Angle: 65°

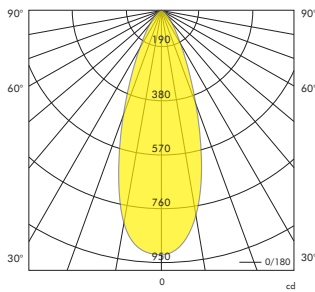

PRODUCT LIST

Article No.	Product Name	Color	LED Lumen	CCT	CRI	LED Power	Reflector	Cutout size
2.11.3174 / 2.11.3175 ¹	Smooth Adjustable Round Deep Reflector	Aluminium	520lm	2700K	>90Ra	6W	38°	Ø 75mm
2.11.3177 / 2.11.3178 ¹	Smooth Adjustable Round Deep Reflector	Sandy White	520lm	2700K	>90Ra	6W	38°	Ø 75mm
2.11.3180 / 2.11.3181 ¹	Smooth Adjustable Round Deep Reflector	Aluminium	550lm	3000K	>90Ra	6W	38°	Ø 75mm
2.11.3183 / 2.11.3184 ¹	Smooth Adjustable Round Deep Reflector	Sandy White	550lm	3000K	>90Ra	6W	38°	Ø 75mm

¹ Article No. with ¹ indicates dimmable driver is included.

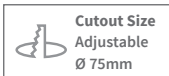
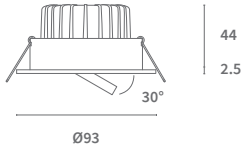

2-light Ceiling Frame
Cutout Size 80 x 155mm
(not included)

AVAILABLE BEAM ANGLES

Article No.	Description	Color
2.01.0720	2-light Ceiling Frame for Smooth 8.4W Spot Light	Aluminium
2.01.0721	2-light Ceiling Frame for Smooth 8.4W Spot Light	White
-----	For 2-light Smooth 8.4W Adjustable, please order 2 x single lights and 1 x 2-light Ceiling Frame.	

AVAILABLE DRIVERS

Article No.	Description
-----	DALI Dimmable driver
-----	1-10V Dimmable driver



Smooth

Spot Light

Adjustable Round

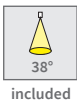

System Power	16W	
CRI	>90Ra	
CCT	2700K	3000K
LED Lumen	930lm	1000lm
LED Efficacy	78lm/W	83lm/W
LOR	>82%	
Driver	350mA Non-Dimmable or Dimmable Driver (included)	

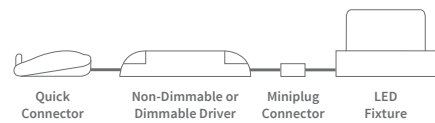

Smooth 16W 3000K

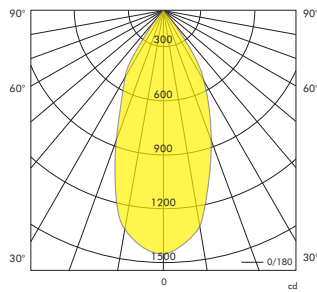
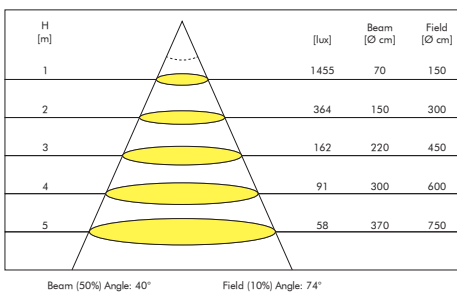

PRODUCT LIST

Article No.	Product Name	Color	LED Lumen	CCT	CRI	LED Power	Reflector	Cutout size
2.11.1678 / 2.11.1679 ¹	Smooth Adjustable Round	Aluminium	930lm	2700K	>90Ra	12W	38°	Ø 95mm
2.11.1681 / 2.11.1682 ¹	Smooth Adjustable Round	Sandy White	930lm	2700K	>90Ra	12W	38°	Ø 95mm
2.11.1684 / 2.11.1685 ¹	Smooth Adjustable Round	Aluminium	1000lm	3000K	>90Ra	12W	38°	Ø 95mm
2.11.1687 / 2.11.1688 ¹	Smooth Adjustable Round	Sandy White	1000lm	3000K	>90Ra	12W	38°	Ø 95mm

¹ Article No. with ¹ indicates dimmable driver is included.

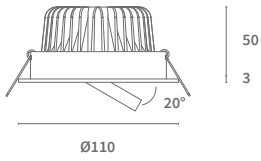

AVAILABLE DRIVERS

Article No.	Description
-----	DALI Dimmable driver
-----	1-10V Dimmable driver



Smooth

Spot Light

Adjustable Square Deep



System Power	8.4W	
CRI	>90Ra	
CCT	2700K	3000K
LED Lumen	520lm	550lm
LED Efficacy	86lm/W	91lm/W
LOR	>70%	
Driver	Non-Dimmable or Dimmable Driver (included)	

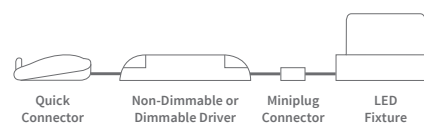

Smooth 8.4W 3000K

H [m]	[lux]	Beam [Ø cm]	Field [Ø cm]
1	919	68	128
2	230	137	257
3	102	205	385
4	58	273	513
5	37	341	642

Beam (50%) Angle: 38° Field (10%) Angle: 65°

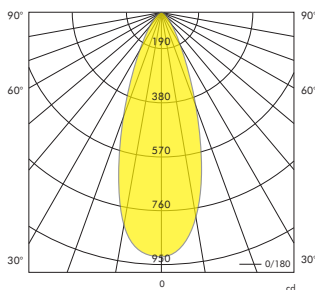

PRODUCT LIST

Article No.	Product Name	Color	LED Lumen	CCT	CRI	LED Power	Reflector	Cutout size
2.11.3186 / 2.11.3187 ¹	Smooth Adjustable Square Deep Reflector	Aluminium	520lm	2700K	>90Ra	6W	38°	Ø 68mm
2.11.3289 / 2.11.3290 ¹	Smooth Adjustable Square Deep Reflector	Sandy White	520lm	2700K	>90Ra	6W	38°	Ø 68mm
2.11.3292 / 2.11.3293 ¹	Smooth Adjustable Square Deep Reflector	Aluminium	550lm	3000K	>90Ra	6W	38°	Ø 68mm
2.11.3295 / 2.11.3296 ¹	Smooth Adjustable Square Deep Reflector	Sandy White	550lm	3000K	>90Ra	6W	38°	Ø 68mm

¹ Article No. with ¹ indicates dimmable driver is included.

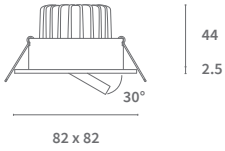

AVAILABLE DRIVERS

Article No.	Description
-----	DALI Dimmable driver
-----	1-10V Dimmable driver



Smooth

Spot Light

Adjustable Square Deep



System Power	8.4W	
CRI	>90Ra	
CCT	2700K	3000K
LED Lumen	520lm	550lm
LED Efficacy	84lm/W	89lm/W
LOR	>70%	
Driver	350mA Non-Dimmable or Dimmable Driver (included)	

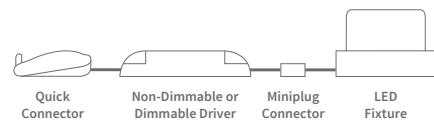

Smooth 8.4W 3000K

H [m]	[lux]	Beam [Ø cm]	Field [Ø cm]
1	919	68	128
2	230	137	257
3	102	205	385
4	58	273	513
5	37	341	642

Beam (50%) Angle: 38° Field (10%) Angle: 65°

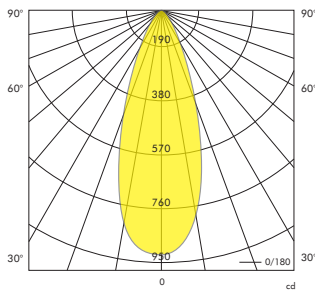

PRODUCT LIST

Article No.	Product Name	Color	LED Lumen	CCT	CRI	LED Power	Reflector	Cutout size
2.11.3198 / 2.11.3199 ¹	Smooth Adjustable Square Deep Reflector	Aluminium	520lm	2700K	>90Ra	6W	38°	Ø 75mm
2.11.3201 / 2.11.3202 ¹	Smooth Adjustable Square Deep Reflector	Sandy White	520lm	2700K	>90Ra	6W	38°	Ø 75mm
2.11.3204 / 2.11.3205 ¹	Smooth Adjustable Square Deep Reflector	Aluminium	550lm	3000K	>90Ra	6W	38°	Ø 75mm
2.11.3207 / 2.11.3208 ¹	Smooth Adjustable Square Deep Reflector	Sandy White	550lm	3000K	>90Ra	6W	38°	Ø 75mm

¹ Article No. with ¹ indicates dimmable driver is included.

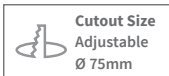
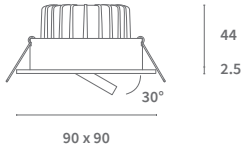

2-light Ceiling Frame
Cutout Size 80 x 155mm
(not included)

AVAILABLE BEAM ANGLES

Article No.	Description	Color
2.01.0720	2-light Ceiling Frame for Smooth 8.4W Spot Light	Aluminium
2.01.0721	2-light Ceiling Frame for Smooth 8.4W Spot Light	White
-----	For 2-light Smooth 8.4W Adjustable, please order 2 x single lights and 1 x 2-light Ceiling Frame.	

AVAILABLE DRIVERS

Article No.	Description
-----	DALI Dimmable driver
-----	1-10V Dimmable driver



Etage

Spot Light

Deep Round & Square Adjustable

Also available

6W - 350mA

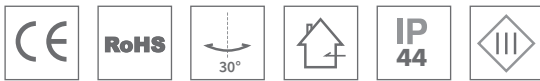

Low-Glare included

System Power	13W		
CRI	>90Ra		
CCT	2700K	3000K	4000K
LED Lumen	700lm	740lm	790lm
LED Efficacy	78lm/W	82lm/W	88lm/W
LOR	83%		
Driver	500mA Non-Dimmable or Dimmable Driver (included)		

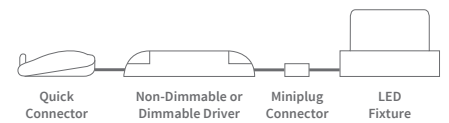

Etage 13W 2700K

H [m]	[lux]	Beam [Ø cm]	Field [Ø cm]
1	1361	60	140
2	340	120	290
3	151	180	430
4	85	240	580
5	55	310	720

Beam (50%) Angle: 34°

Field (10%) Angle: 71°

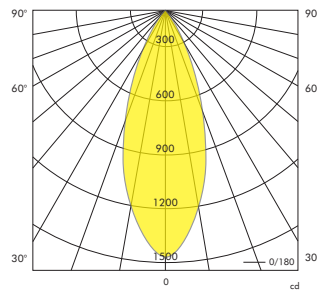

PRODUCT LIST

Article No.	Product Name	Color	LED Lumen	CCT	CRI	LED Power	Reflector	Cutout size
2.11.2011 / 2.11.2012 ¹	Etage Round	Grey	700lm	2700K	>90Ra	9W	38°	Ø 83mm
2.11.2017 / 2.11.2018 ¹	Etage Round	White	700lm	2700K	>90Ra	9W	38°	Ø 83mm
2.11.2023 / 2.11.2024 ¹	Etage Round	Black	700lm	2700K	>90Ra	9W	38°	Ø 83mm
2.11.2013 / 2.11.2014 ¹	Etage Round	Grey	740lm	3000K	>90Ra	9W	38°	Ø 83mm
2.11.2019 / 2.11.2020 ¹	Etage Round	White	740lm	3000K	>90Ra	9W	38°	Ø 83mm
2.11.2025 / 2.11.2026 ¹	Etage Round	Black	740lm	3000K	>90Ra	9W	38°	Ø 83mm
2.11.2015 / 2.11.2016 ¹	Etage Round	Grey	790lm	4000K	>90Ra	9W	38°	Ø 83mm
2.11.2021 / 2.11.2022 ¹	Etage Round	White	790lm	4000K	>90Ra	9W	38°	Ø 83mm
2.11.2027 / 2.11.2028 ¹	Etage Round	Black	790lm	4000K	>90Ra	9W	38°	Ø 83mm

PRODUCT LIST

Article No.	Product Name	Color	LED Lumen	CCT	CRI	LED Power	Reflector	Cutout size
2.11.2029 / 2.11.2030 ¹	Etage Square	Grey	700lm	2700K	>90Ra	9W	38°	Ø 83mm
2.11.2035 / 2.11.2036 ¹	Etage Square	White	700lm	2700K	>90Ra	9W	38°	Ø 83mm
2.11.2041 / 2.11.2042 ¹	Etage Square	Black	700lm	2700K	>90Ra	9W	38°	Ø 83mm
2.11.2031 / 2.11.2032 ¹	Etage Square	Grey	740lm	3000K	>90Ra	9W	38°	Ø 83mm
2.11.2037 / 2.11.2038 ¹	Etage Square	White	740lm	3000K	>90Ra	9W	38°	Ø 83mm
2.11.2043 / 2.11.2044 ¹	Etage Square	Black	740lm	3000K	>90Ra	9W	38°	Ø 83mm
2.11.2033 / 2.11.2034 ¹	Etage Square	Grey	790lm	4000K	>90Ra	9W	38°	Ø 83mm
2.11.2039 / 2.11.2040 ¹	Etage Square	White	790lm	4000K	>90Ra	9W	38°	Ø 83mm
2.11.2045 / 2.11.2046 ¹	Etage Square	Black	790lm	4000K	>90Ra	9W	38°	Ø 83mm

¹ Article No. with ¹ indicates dimmable driver is included.

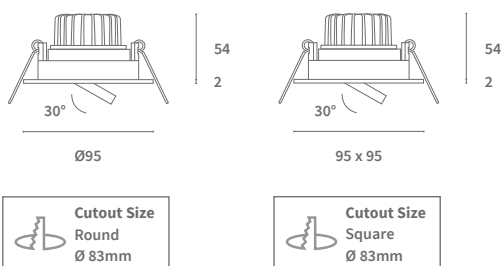

ALSO AVAILABLE

Article No.	Description
-----	6W - 350mA version available on request

AVAILABLE DRIVERS

Article No.	Description
-----	DALI Dimmable driver
-----	1-10V Dimmable driver



Aqua

Spot Light

Fixed Round



System Power	8.4W	
CRI	>90Ra	
CCT	2700K	3000K
LED Lumen	520lm	550lm
LED Efficacy	84lm/W	89lm/W
Driver	350mA Non-Dimmable or Dimmable Driver (included)	

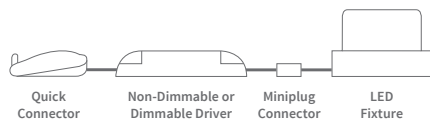

Aqua 8.4W 3000K

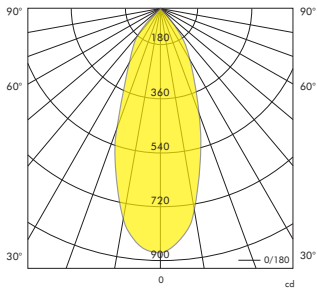
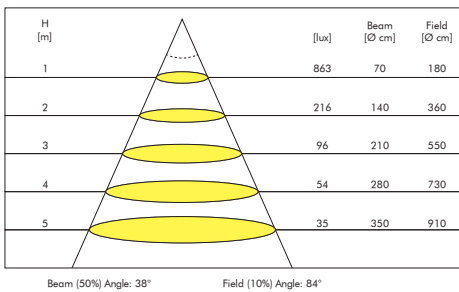

PRODUCT LIST

Article No.	Product Name	Color	LED Lumen	CCT	CRI	LED Power	Reflector	Cutout size
2.11.1690 / 2.11.1691 ¹	Aqua IP65	Aluminium	520lm	2700K	>90Ra	6W	38°	Ø 60mm
2.11.1693 / 2.11.1694 ¹	Aqua IP65	White	520lm	2700K	>90Ra	6W	38°	Ø 60mm
2.11.1696 / 2.11.1697 ¹	Aqua IP65	Aluminium	550lm	3000K	>90Ra	6W	38°	Ø 60mm
2.11.1699 / 2.11.1700 ¹	Aqua IP65	White	550lm	3000K	>90Ra	6W	38°	Ø 60mm

¹ Article No. with ¹ indicates dimmable driver is included.

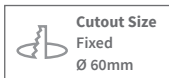
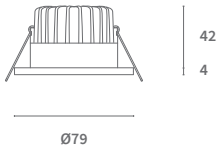

AVAILABLE DRIVERS

Article No.	Description
-----	DALI Dimmable driver
-----	1-10V Dimmable driver



Asta Trimless

Spot Light
GU10



Power	Max. 50W
Lamp Holder	GU10
Lamp Type	MR16 (50mm) (not included)
Input Voltage	230V



PRODUCT LIST

Article No.	Product Name	Color	Lamp Type	Input Voltage	Power	Cutout size
2.11.2585	Asta Trimless GU10 1-light	White	MR16 (50mm)	230V	Max. 50W	97 x 97mm
2.11.2586	Asta Trimless GU10 1-light	Black	MR16 (50mm)	230V	Max. 50W	97 x 97mm
2.11.2587	Asta Trimless GU10 2-light	White	MR16 (50mm)	230V	Max. 2 x 50W	181 x 97mm
2.11.2588	Asta Trimless GU10 2-light	Black	MR16 (50mm)	230V	Max. 2 x 50W	181 x 83mm

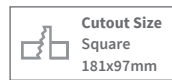
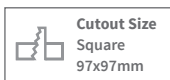
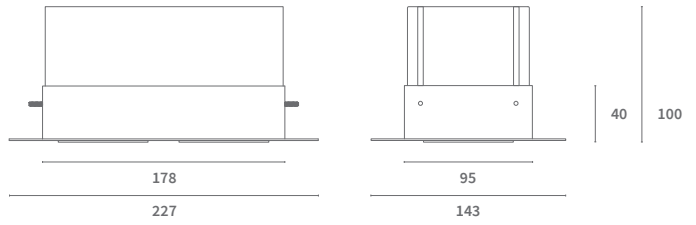
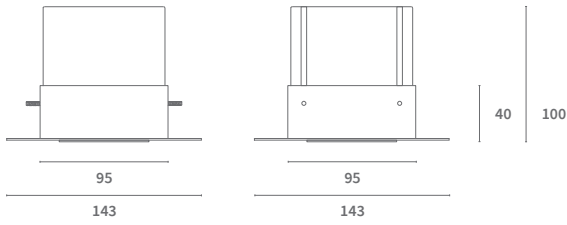

ALSO AVAILABLE

Article No.	Description
-----	QR111 version available on request



Tondo

Spot Light

Adjustable Round

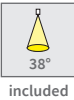

System Power	12W		
CRI	>95Ra		
CCT	2700K	3000K	4000K
LED Lumen	700lm	740lm	820lm
LED Efficacy	78lm/W	82lm/W	91lm/W
LOR	Up to 80%		
Driver	500mA Non-Dimmable or Dimmable Driver (included)		

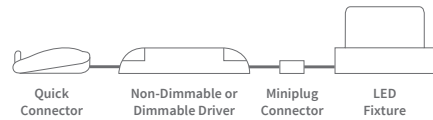

Tondo 12W 3000K

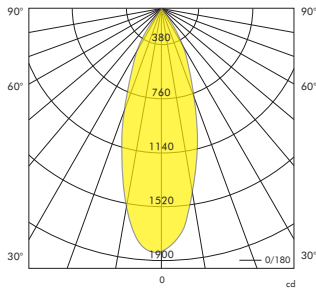
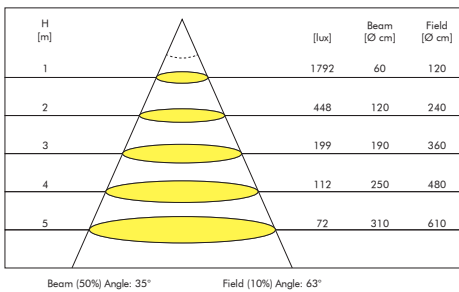

PRODUCT LIST

Article No.	Product Name	Color	LED Lumen	CCT	CRI	LED Power	Reflector	Cutout size
2.11.2974 / 2.11.2975 ¹	Tondo	White	700lm	2700K	>95Ra	9W	38°	Ø 80mm
2.11.2980 / 2.11.2981 ¹	Tondo	Black	700lm	2700K	>95Ra	9W	38°	Ø 80mm
2.11.2976 / 2.11.2977 ¹	Tondo	White	740lm	3000K	>95Ra	9W	38°	Ø 80mm
2.11.2982 / 2.11.2983 ¹	Tondo	Black	740lm	3000K	>95Ra	9W	38°	Ø 80mm
2.11.2978 / 2.11.2979 ¹	Tondo	White	820lm	4000K	>95Ra	9W	38°	Ø 80mm
2.11.2984 / 2.11.2985 ¹	Tondo	Black	820lm	4000K	>95Ra	9W	38°	Ø 80mm

¹Article No. with ¹ indicates dimmable driver is included.

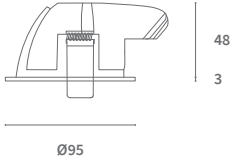

AVAILABLE DRIVERS

Article No.	Description
-----	DALI Dimmable driver
-----	1-10V Dimmable driver



Vide

Spot Light Adjustable

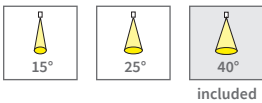

LED Power	20W		
CRI	>95Ra		>90Ra
CCT	2700K	3000K	4000K
LED Lumen	1300lm	1350lm	1400lm
LED Efficacy	65lm/W	67lm/W	70lm/W
LOR	>85%		
Driver	500mA Dimmable Driver (included)		

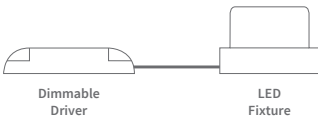

Vide 20W 3000K

H [m]	[lux]	Beam [Ø cm]	Field [Ø cm]
1	3335	65	117
2	834	129	235
3	371	194	352
4	208	258	469
5	133	323	587

Beam (50%) Angle: 36° Field (10%) Angle: 61°

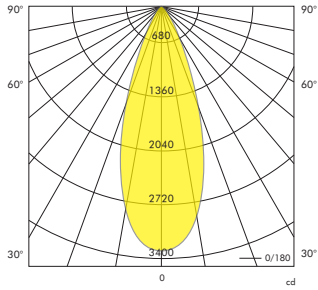

PRODUCT LIST

Article No.	Product Name	Housing Color	Ring Color	LED Lumen	CCT	CRI	LED Power	Reflector	Cutout size
2.17.1028	Vide Recessed	Grey	Grey	1300lm	2700K	>95Ra	20W	40°	Ø 90mm
2.17.1073	Vide Recessed	White	White	1300lm	2700K	>95Ra	20W	40°	Ø 90mm
2.17.1118	Vide Recessed	Black	Black	1300lm	2700K	>95Ra	20W	40°	Ø 90mm
2.17.1031	Vide Recessed	Grey	Grey	1350lm	3000K	>95Ra	20W	40°	Ø 90mm
2.17.1076	Vide Recessed	White	White	1350lm	3000K	>95Ra	20W	40°	Ø 90mm
2.17.1121	Vide Recessed	Black	Black	1350lm	3000K	>95Ra	20W	40°	Ø 90mm
2.17.1034	Vide Recessed	Grey	Grey	1400lm	4000K	>90Ra	20W	40°	Ø 90mm
2.17.1079	Vide Recessed	White	White	1400lm	4000K	>90Ra	20W	40°	Ø 90mm
2.17.1124	Vide Recessed	Black	Black	1400lm	4000K	>90Ra	20W	40°	Ø 90mm

Also available: other color combinations
 This is a small selection from our portfolio. Please contact us for a suitable solution for your lighting project.

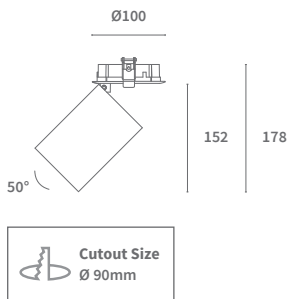

AVAILABLE BEAM ANGLES

Article No.	Description
5.14.0210	Reflector 15° for Vide
5.14.0211	Reflector 25° for Vide

ALSO AVAILABLE

Article No.	Description	Color
2.01.0927	Ring for Vide	Gold
2.01.0928	Ring for Vide	Grey
2.01.0929	Ring for Vide	White
2.01.0930	Ring for Vide	Black



Flox

Downlight
Fixed

Also available



LED Power	24W	42W	
CRI	>90Ra		
CCT	3000K	3000K	3000K PW
LED Lumen	3100lm	5300lm	5300lm
LED Efficacy	129lm/W	126lm/W	126lm/W
LOR	Up to 85%		
Driver	Non-Dimmable Driver (included in downlight module)		

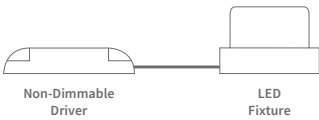

Flox 42W 3000K

H [m]	[lux]	Beam [Ø cm]	Field [Ø cm]
1	7528	70	130
2	1883	140	270
3	837	220	400
4	470	290	540
5	302	360	670

Beam (50%) Angle: 40° Field (10%) Angle: 68°

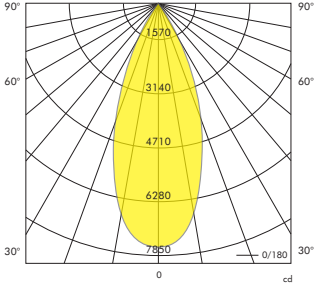

PRODUCT LIST

Article No.	Product Name	Color	LED Lumen	CCT	CRI	LED Power	Reflector	Cutout size
2.11.2571	Flox Fixed	Grey	3100lm	3000K	>90Ra	24W	38°	Ø 140mm
2.11.2572	Flox Fixed	White	3100lm	3000K	>90Ra	24W	38°	Ø 140mm
2.11.2573	Flox Fixed	Black	3100lm	3000K	>90Ra	24W	38°	Ø 140mm
2.11.4166	Flox Fixed	Grey	5300lm	3000K	>90Ra	42W	38°	Ø 140mm
2.11.2174	Flox Fixed	White	5300lm	3000K	>90Ra	42W	38°	Ø 140mm
2.11.4167	Flox Fixed	Black	5300lm	3000K	>90Ra	42W	38°	Ø 140mm
2.11.2507	Flox Fixed	Grey	5300lm	3000K PW	>90Ra	42W	38°	Ø 140mm
2.11.2511	Flox Fixed	White	5300lm	3000K PW	>90Ra	42W	38°	Ø 140mm
2.11.2515	Flox Fixed	Black	5300lm	3000K PW	>90Ra	42W	38°	Ø 140mm

Also available: CRI >80Ra

This is a small selection from our portfolio. Please contact us for a suitable solution for your lighting project.

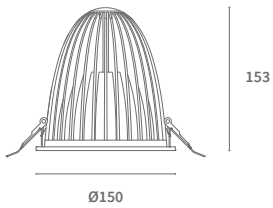

AVAILABLE BEAM ANGLES

Article No.	Description
5.14.0153	Reflector 18° for Flox
5.14.0154	Reflector 28° for Flox
5.14.0156	Reflector 60° for Flox

AVAILABLE DRIVERS

Article No.	Description
-----	Dimmable driver



Flox

Downlight
Adjustable

Also available



LED Power	24W	42W
CRI	>90Ra	
CCT	3000K	3000K
LED Lumen	3100lm	5300lm
LED Efficacy	129lm/W	126lm/W
LOR	Up to 85%	
Driver	Non-Dimmable Driver (included in downlight module)	

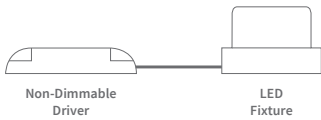

Flox 42W 3000K

H [m]	[lux]	Beam [Ø cm]	Field [Ø cm]
1	7528	70	130
2	1883	140	270
3	837	220	400
4	470	290	540
5	302	360	670

Beam (50%) Angle: 40° Field (10%) Angle: 68°

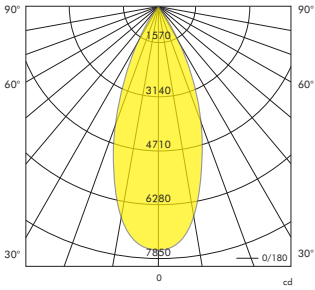

PRODUCT LIST

Article No.	Product Name	Color	LED Lumen	CCT	CRI	LED Power	Reflector	Cutout size
2.11.1498	Flox Adjustable	Grey	3100lm	3000K	>90Ra	24W	38°	Ø 162mm
2.11.1499	Flox Adjustable	White	3100lm	3000K	>90Ra	24W	38°	Ø 162mm
2.11.1500	Flox Adjustable	Black	3100lm	3000K	>90Ra	24W	38°	Ø 162mm
2.11.2341	Flox Adjustable	Grey	5300lm	3000K	>90Ra	42W	38°	Ø 162mm
2.11.2342	Flox Adjustable	White	5300lm	3000K	>90Ra	42W	38°	Ø 162mm
2.11.2343	Flox Adjustable	Black	5300lm	3000K	>90Ra	42W	38°	Ø 162mm

Also available: CRI >80Ra
 This is a small selection from our portfolio. Please contact us for a suitable solution for your lighting project.

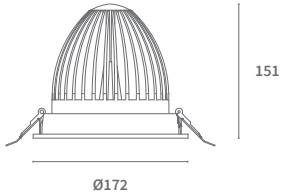

AVAILABLE BEAM ANGLES

Article No.	Description
5.14.0153	Reflector 18° for Flox
5.14.0154	Reflector 28° for Flox
5.14.0156	Reflector 60° for Flox

AVAILABLE DRIVERS

Article No.	Description
-----	Dimmable driver



Movimento

Downlight
Kardan

Also available

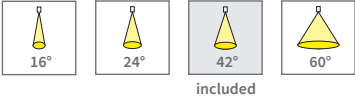

LED Power	24W			42W		
CRI	>90Ra					
CCT	2700K	3000K	4000K PW	2700K	3000K	4000K PW
LED Lumen	2950lm	3100lm	3300lm	5050lm	5300lm	5700lm
LED Efficacy	122lm/W	129lm/W	137lm/W	120lm/W	126lm/W	136lm/W
LOR	Up to 85%					
Driver	Non-Dimmable Driver (included in downlight module)					

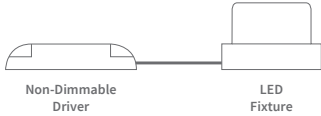

Movimento 24W 3000K

H [m]	[lux]	Beam [Ø cm]	Field [Ø cm]
1	5871	70	130
2	1467	140	260
3	652	210	390
4	367	280	530
5	236	350	660

Beam (50%) Angle: 38° Field (10%) Angle: 67°

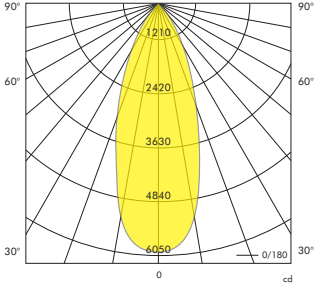

PRODUCT LIST

Article No.	Product Name	Color	LED Lumen	CCT	CRI	LED Power	Reflector	Cutout size
2.11.2882	Movimento	White	2950lm	2700K	>90Ra	24W	42°	Ø 175mm
2.11.2154	Movimento	White	3100lm	3000K	>90Ra	24W	42°	Ø 175mm
2.11.4192	Movimento	White	3300lm	4000K PW	>90Ra	24W	42°	Ø 175mm
2.11.4160	Movimento	White	5050lm	2700K	>90Ra	42W	42°	Ø 175mm
2.11.1702	Movimento	White	5300lm	3000K	>90Ra	42W	42°	Ø 175mm
2.11.2960	Movimento	White	5700lm	4000K PW	>90Ra	42W	42°	Ø 175mm

Also available: CRI >80Ra

This is a small selection from our portfolio. Please contact us for a suitable solution for your lighting project.

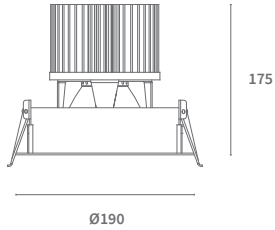

AVAILABLE BEAM ANGLES

Article No.	Description
5.14.0129	Reflector 16° for Movimento
5.14.0130	Reflector 24° for Movimento
5.14.0223	Reflector 60° for Movimento

AVAILABLE DRIVERS

Article No.	Description
-----	Dimmable driver

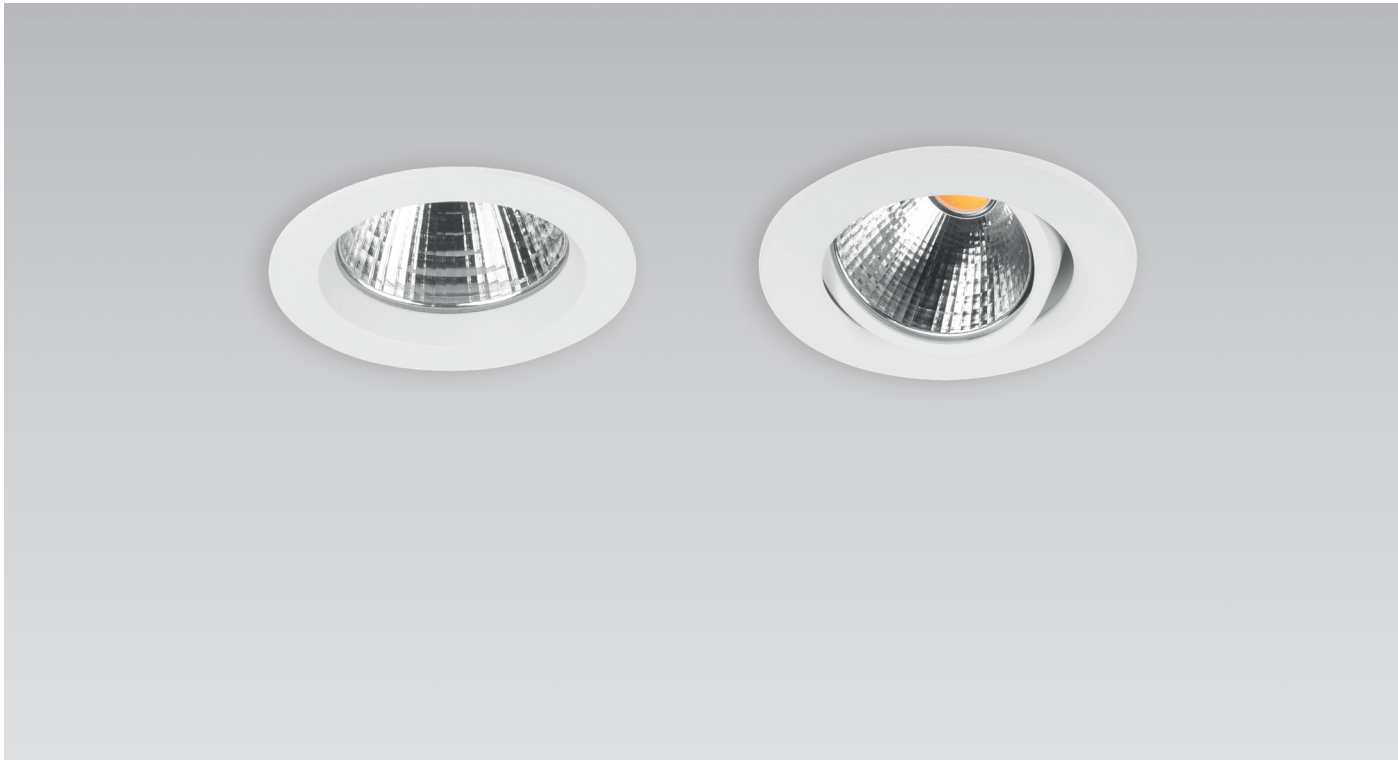

Flo

Downlight

Fixed & Adjustable Round

Also available



LED Power	17W	24W	32W
CRI	>90Ra		
CCT	3000K	3000K	3000K PW
LED Lumen	2200lm	3100lm	4350lm
LED Efficacy	129lm/W	129lm/W	135lm/W
LOR	Up to 85%		
Driver	Non-Dimmable Driver (included)		

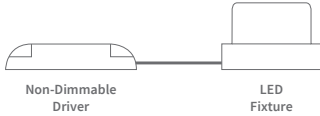

Flo 24W 3000K

H [m]	[lux]	Beam [Ø cm]	Field [Ø cm]
1	4792	70	140
2	1198	130	290
3	532	200	430
4	299	270	570
5	192	340	710

Beam (50%) Angle: 37° Field (10%) Angle: 71°

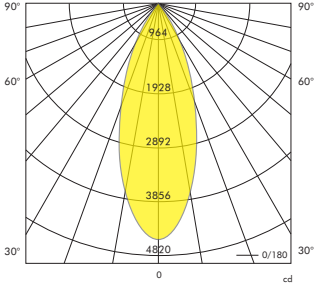

PRODUCT LIST								
Article No.	Product Name	Color	LED Lumen	CCT	CRI	LED Power	Reflector	Cutout size
2.11.1485	Flo Fixed Round	Grey	2200lm	3000K	>90Ra	17W	36°	Ø 97mm
2.11.1486	Flo Fixed Round	White	2200lm	3000K	>90Ra	17W	36°	Ø 97mm
2.11.1487	Flo Fixed Round	Black	2200lm	3000K	>90Ra	17W	36°	Ø 97mm
2.11.2563	Flo Fixed Round	Grey	3100lm	3000K	>90Ra	24W	36°	Ø 97mm
2.11.2329	Flo Fixed Round	White	3100lm	3000K	>90Ra	24W	36°	Ø 97mm
2.11.2564	Flo Fixed Round	Black	3100lm	3000K	>90Ra	24W	36°	Ø 97mm
2.11.2456	Flo Fixed Round	Grey	4350lm	3000K PW	>90Ra	32W	36°	Ø 97mm
2.11.2408	Flo Fixed Round	White	4350lm	3000K PW	>90Ra	32W	36°	Ø 97mm
2.11.2460	Flo Fixed Round	Black	4350lm	3000K PW	>90Ra	32W	36°	Ø 97mm

PRODUCT LIST								
Article No.	Product Name	Color	LED Lumen	CCT	CRI	LED Power	Reflector	Cutout size
2.11.1488	Flo Adjustable Round	Grey	2200lm	3000K	>90Ra	17W	36°	Ø 117mm
2.11.1489	Flo Adjustable Round	White	2200lm	3000K	>90Ra	17W	36°	Ø 117mm
2.11.1490	Flo Adjustable Round	Black	2200lm	3000K	>90Ra	17W	36°	Ø 117mm
2.11.1491	Flo Adjustable Round	Grey	3100lm	3000K	>90Ra	24W	36°	Ø 117mm
2.11.1492	Flo Adjustable Round	White	3100lm	3000K	>90Ra	24W	36°	Ø 117mm
2.11.1493	Flo Adjustable Round	Black	3100lm	3000K	>90Ra	24W	36°	Ø 117mm
2.11.2480	Flo Adjustable Round	Grey	4350lm	3000K PW	>90Ra	32W	36°	Ø 117mm
2.11.2483	Flo Adjustable Round	White	4350lm	3000K PW	>90Ra	32W	36°	Ø 117mm
2.11.2486	Flo Adjustable Round	Black	4350lm	3000K PW	>90Ra	32W	36°	Ø 117mm

Also available: CRI >80Ra

This is a small selection from our portfolio. Please contact us for a suitable solution for your lighting project.

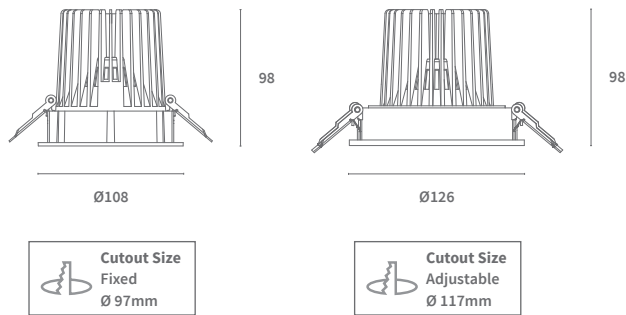

AVAILABLE BEAM ANGLES

Article No.	Description
5.14.0149	Reflector 15° for Downlight Flo
5.14.0150	Reflector 24° for Downlight Flo
5.14.0152	Reflector 60° for Downlight Flo

AVAILABLE DRIVERS

Article No.	Description
-----	Dimmable driver



Exo

Downlight

Kardan Square 1 & 2-light

Also available

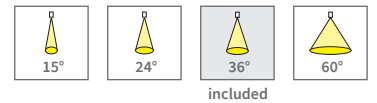

LED Power	17W		24W	
CRI	>90Ra			
CCT	2700K	3000K	2700K	3000K
LED Lumen	2100lm	2200lm	2950lm	3100lm
LED Efficacy	123lm/W	129lm/W	123lm/W	130lm/W
LOR	Up to 85%			
Driver	Non-Dimmable Driver (included)			

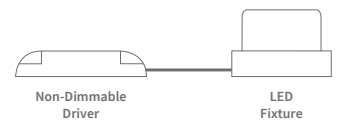

Exo 24W 3000K (per spot head)

H [m]	[lux]	Beam [Ø cm]	Field [Ø cm]
1	4792	70	140
2	1198	130	290
3	532	200	430
4	299	270	570
5	192	340	710

Beam (50%) Angle: 37° Field (10%) Angle: 71°

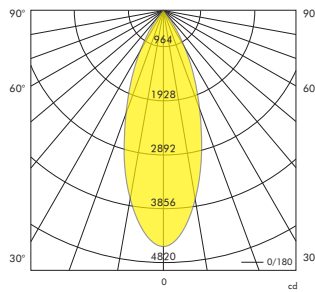

PRODUCT LIST

Article No.	Product Name	Color	LED Lumen	CCT	CRI	LED Power	Reflector	Cutout size
2.11.4178	Exo Adjustable Square 1-light	Grey	2200lm	3000K	>90Ra	17W	36°	Ø 117mm
2.11.2122	Exo Adjustable Square 1-light	White	2200lm	3000K	>90Ra	17W	36°	Ø 117mm
2.11.4179	Exo Adjustable Square 1-light	Black	2200lm	3000K	>90Ra	17W	36°	Ø 117mm
2.11.2559	Exo Adjustable Square 1-light	Grey	3100lm	3000K	>90Ra	24W	36°	Ø 117mm
2.11.1606	Exo Adjustable Square 1-light	White	3100lm	3000K	>90Ra	24W	36°	Ø 117mm
2.11.2560	Exo Adjustable Square 1-light	Black	3100lm	3000K	>90Ra	24W	36°	Ø 117mm

PRODUCT LIST

Article No.	Product Name	Color	LED Lumen	CCT	CRI	LED Power	Reflector	Cutout size
2.11.4180	Exo Adjustable Square 2-light	Grey	2 x 2200lm	3000K	>90Ra	2 x 17W	36°	227 x 117mm
2.11.2118	Exo Adjustable Square 2-light	White	2 x 2200lm	3000K	>90Ra	2 x 17W	36°	227 x 117mm
2.11.4181	Exo Adjustable Square 2-light	Black	2 x 2200lm	3000K	>90Ra	2 x 17W	36°	227 x 117mm
2.11.2561	Exo Adjustable Square 2-light	Grey	2 x 3100lm	3000K	>90Ra	2 x 24W	36°	227 x 117mm
2.11.2064	Exo Adjustable Square 2-light	White	2 x 3100lm	3000K	>90Ra	2 x 24W	36°	227 x 117mm
2.11.2562	Exo Adjustable Square 2-light	Black	2 x 3100lm	3000K	>90Ra	2 x 24W	36°	227 x 117mm

Also available: CRI >80Ra
 This is a small selection from our portfolio. Please contact us for a suitable solution for your lighting project.

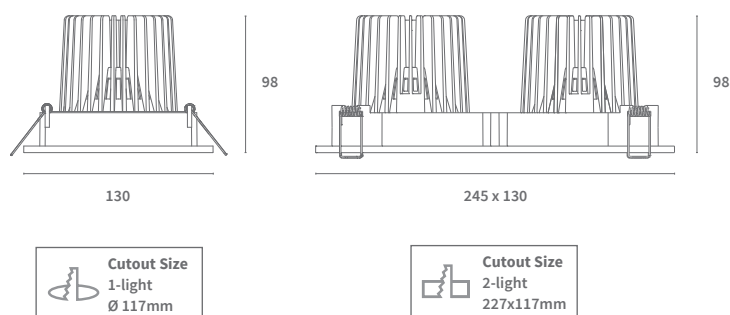

AVAILABLE BEAM ANGLES

Article No.	Description
5.14.0149	Reflector 15° for Exo
5.14.0150	Reflector 24° for Exo
5.14.0152	Reflector 60° for Exo
2.01.0973	Honeycomb Louvre for Exo

AVAILABLE DRIVERS

Article No.	Description
-----	Dimmable driver



Flo

Downlight

Adjustable Square 1 & 2-light

Also available

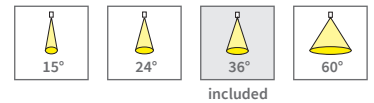

LED Power	17W		24W	
CRI	>90Ra			
CCT	2700K	3000K	2700K	3000K
LED Lumen	2100lm	2200lm	2950lm	3100lm
LED Efficacy	123lm/W	129lm/W	123lm/W	130lm/W
LOR	Up to 85%			
Driver	Non-Dimmable Driver (included)			

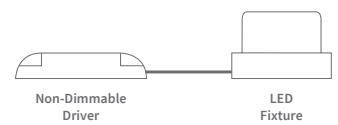

Flo 24W 3000K (per spot head)

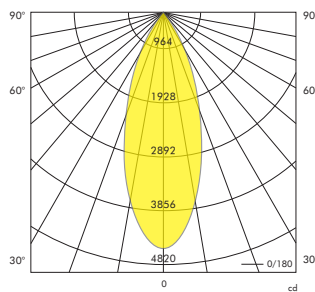
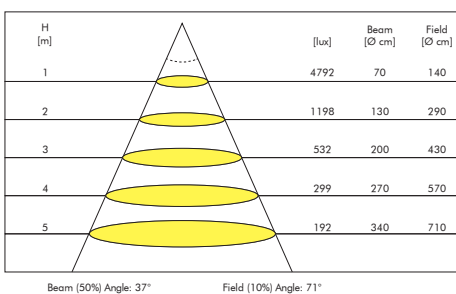

PRODUCT LIST

Article No.	Product Name	Color	LED Lumen	CCT	CRI	LED Power	Reflector	Cutout size
2.11.4172	Flo Adjustable Square 1-light	Grey	2100lm	2700K	>90Ra	17W	36°	Ø 117mm
2.11.2606	Flo Adjustable Square 1-light	White	2100lm	2700K	>90Ra	17W	36°	Ø 117mm
2.11.2419	Flo Adjustable Square 1-light	Black	2100lm	2700K	>90Ra	17W	36°	Ø 117mm
2.11.4173	Flo Adjustable Square 1-light	Grey	2200lm	3000K	>90Ra	17W	36°	Ø 117mm
2.11.2242	Flo Adjustable Square 1-light	White	2200lm	3000K	>90Ra	17W	36°	Ø 117mm
2.11.4174	Flo Adjustable Square 1-light	Black	2200lm	3000K	>90Ra	17W	36°	Ø 117mm
2.11.1569	Flo Adjustable Square 1-light	Grey	2950lm	2700K	>90Ra	24W	36°	Ø 117mm
2.11.1570	Flo Adjustable Square 1-light	White	2950lm	2700K	>90Ra	24W	36°	Ø 117mm
2.11.1571	Flo Adjustable Square 1-light	Black	2950lm	2700K	>90Ra	24W	36°	Ø 117mm
2.11.2565	Flo Adjustable Square 1-light	Grey	3100lm	3000K	>90Ra	24W	36°	Ø 117mm
2.11.2566	Flo Adjustable Square 1-light	White	3100lm	3000K	>90Ra	24W	36°	Ø 117mm
2.11.2567	Flo Adjustable Square 1-light	Black	3100lm	3000K	>90Ra	24W	36°	Ø 117mm

PRODUCT LIST

Article No.	Product Name	Color	LED Lumen	CCT	CRI	LED Power	Reflector	Cutout size
2.11.1572	Flo Adjustable Square 2-light	Grey	2 x 2950lm	2700K	>90Ra	2 x 24W	36°	232 x 112mm
2.11.1573	Flo Adjustable Square 2-light	White	2 x 2950lm	2700K	>90Ra	2 x 24W	36°	232 x 112mm
2.11.1574	Flo Adjustable Square 2-light	Black	2 x 2950lm	2700K	>90Ra	2 x 24W	36°	232 x 112mm
2.11.2568	Flo Adjustable Square 2-light	Grey	2 x 3100lm	3000K	>90Ra	2 x 24W	36°	232 x 112mm
2.11.2569	Flo Adjustable Square 2-light	White	2 x 3100lm	3000K	>90Ra	2 x 24W	36°	232 x 112mm
2.11.2570	Flo Adjustable Square 2-light	Black	2 x 3100lm	3000K	>90Ra	2 x 24W	36°	232 x 112mm

Also available: CRI >80Ra
 This is a small selection from our portfolio. Please contact us for a suitable solution for your lighting project.

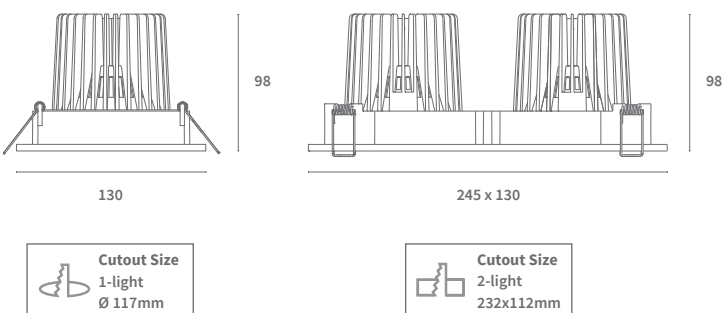

AVAILABLE BEAM ANGLES

Article No.	Description
5.14.0149	Reflector 15° for Downlight Flo
5.14.0150	Reflector 24° for Downlight Flo
5.14.0152	Reflector 60° for Downlight Flo
2.01.0973	Honeycomb Louvre for Flo

AVAILABLE DRIVERS

Article No.	Description
-----	Dimmable driver



Asta

Downlight Kardan

Also available

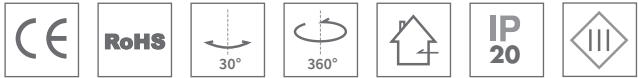

LED Power	24W	42W
CRI	>90Ra	
CCT	3000K	3000K
LED Lumen	3100lm	5300lm
LED Efficacy	129lm/W	126lm/W
LOR	Up to 85%	
Driver	Non-Dimmable Driver (included in downlight module)	

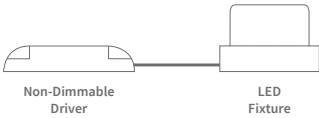

Asta 42W 3000K (per downlight module)

H [m]	[lux]	Beam [Ø cm]	Field [Ø cm]
1	7528	70	130
2	1883	140	270
3	837	220	400
4	470	290	540
5	302	360	670

Beam (50%) Angle: 40° Field (10%) Angle: 68°

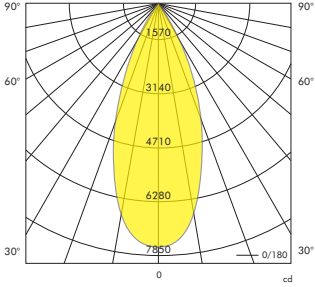

COMBINE CEILING FRAME + DOWNLIGHT MODULE

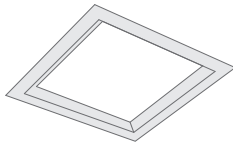

Ceiling Frame



Downlight Module

CEILING FRAME

Article No.	Product Name	Color	Cutout Size
2.11.1049	Installation Frame for Asta Module 1-fold	Grey	205 x 195mm
2.11.1050	Installation Frame for Asta Module 1-fold	White	205 x 195mm
2.11.1051	Installation Frame for Asta Module 1-fold	Black	205 x 195mm
2.11.1052	Installation Frame for Asta Module 2-fold	Grey	205 x 370mm
2.11.1053	Installation Frame for Asta Module 2-fold	White	205 x 370mm
2.11.1054	Installation Frame for Asta Module 2-fold	Black	205 x 370mm
2.11.1055	Installation Frame for Asta Module 3-fold	Grey	205 x 540mm
2.11.1056	Installation Frame for Asta Module 3-fold	White	205 x 540mm
2.11.1057	Installation Frame for Asta Module 3-fold	Black	205 x 540mm

DOWNLIGHT MODULE

Article No.	Product Name	Color	LED Lumen	CCT	CRI	LED Power	Reflector
2.11.2390	Asta Module, excl. Frame	Grey	3100lm	3000K	>90Ra	24W	38°
2.11.1497	Asta Module, excl. Frame	White	3100lm	3000K	>90Ra	24W	38°
2.11.2557	Asta Module, excl. Frame	Black	3100lm	3000K	>90Ra	24W	38°
2.11.2096	Asta Module, excl. Frame	Grey	5300lm	3000K	>90Ra	42W	38°
2.11.2097	Asta Module, excl. Frame	White	5300lm	3000K	>90Ra	42W	38°
2.11.2098	Asta Module, excl. Frame	Black	5300lm	3000K	>90Ra	42W	38°

Also available: CRI >80Ra

This is a small selection from our portfolio. Please contact us for a suitable solution for your lighting project.

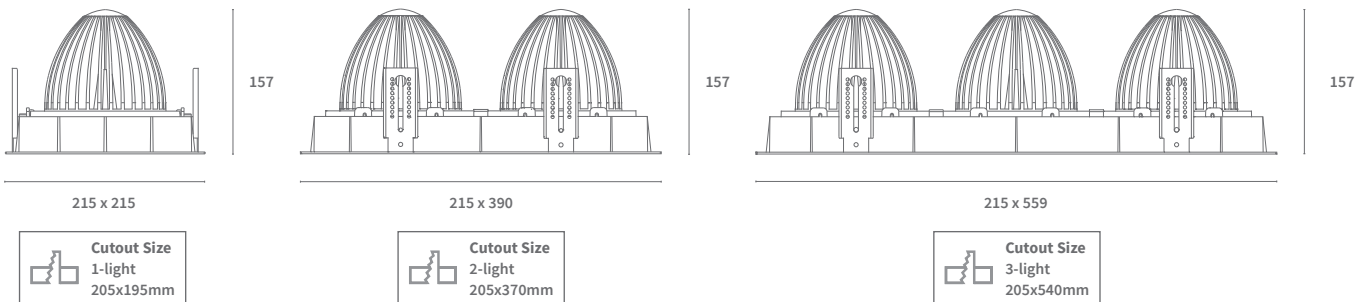

AVAILABLE BEAM ANGLES

Article No.	Description
5.14.0153	Reflector 18° for Asta Module
5.14.0154	Reflector 28° for Asta Module
5.14.0156	Reflector 60° for Asta Module

AVAILABLE DRIVERS

Article No.	Description
-----	Dimmable driver



Exo

Downlight

Kardan Round

Also available

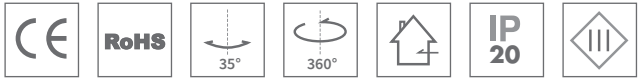

LED Power	17W		24W	
CRI	>90Ra			
CCT	2700K	3000K	2700K	3000K
LED Lumen	2100lm	2200lm	2950lm	3100lm
LED Efficacy	123lm/W	129lm/W	123lm/W	130lm/W
LOR	Up to 85%			
Driver	Non-Dimmable Driver (included)			

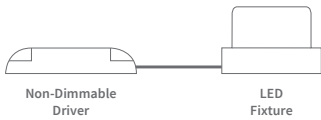

Exo 24W 3000K

H [m]	[lux]	Beam [Ø cm]	Field [Ø cm]
1	4792	70	140
2	1198	130	290
3	532	200	430
4	299	270	570
5	192	340	710

Beam (50%) Angle: 37° Field (10%) Angle: 71°

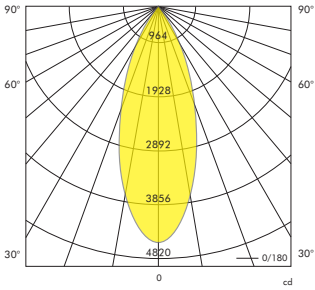

PRODUCT LIST

Article No.	Product Name	Color	LED Lumen	CCT	CRI	LED Power	Reflector	Cutout size
2.11.4175	Exo Kardan Round	Grey	2100lm	2700K	>90Ra	17W	36°	Ø 117mm
2.11.3748	Exo Kardan Round	White	2100lm	2700K	>90Ra	17W	36°	Ø 117mm
2.11.3489	Exo Kardan Round	Black	2100lm	2700K	>90Ra	17W	36°	Ø 117mm
2.11.4176	Exo Kardan Round	Grey	2200lm	3000K	>90Ra	17W	36°	Ø 117mm
2.11.2110	Exo Kardan Round	White	2200lm	3000K	>90Ra	17W	36°	Ø 117mm
2.11.2113	Exo Kardan Round	Black	2200lm	3000K	>90Ra	17W	36°	Ø 117mm
2.11.3591	Exo Kardan Round	Grey	2950lm	2700K	>90Ra	24W	36°	Ø 117mm
2.11.3912	Exo Kardan Round	White	2950lm	2700K	>90Ra	24W	36°	Ø 117mm
2.11.4177	Exo Kardan Round	Black	2950lm	2700K	>90Ra	24W	36°	Ø 117mm
2.11.2558	Exo Kardan Round	Grey	3100lm	3000K	>90Ra	24W	36°	Ø 117mm
2.11.2151	Exo Kardan Round	White	3100lm	3000K	>90Ra	24W	36°	Ø 117mm
2.11.2115	Exo Kardan Round	Black	3100lm	3000K	>90Ra	24W	36°	Ø 117mm

Also available: CRI >80Ra

This is a small selection from our portfolio. Please contact us for a suitable solution for your lighting project.

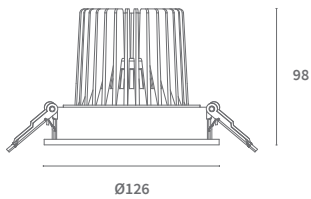

AVAILABLE BEAM ANGLES

Article No.	Description
5.14.0149	Reflector 15° for Exo
5.14.0150	Reflector 24° for Exo
5.14.0152	Reflector 60° for Exo
2.01.0973	Honeycomb Louvre for Exo

AVAILABLE DRIVERS

Article No.	Description
-----	Dimmable driver



Pivo Maxi

Downlight
Adjustable

Also available

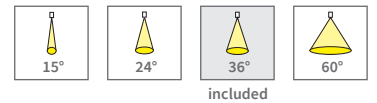

LED Power	24W	42W
CRI	>90Ra	
CCT	3000K	
LED Lumen	3100lm	5300lm
LED Efficacy	129lm/W	126lm/W
LOR	Up to 85%	
Driver	Non-Dimmable Driver (included)	

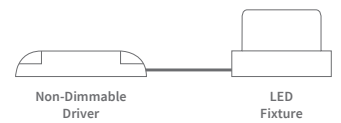

Pivo Maxi 42W 3000K

H [m]	[lux]	Beam [Ø cm]	Field [Ø cm]
1	5689	70	140
2	1422	130	280
3	632	200	420
4	356	260	560
5	228	330	700

Beam (50%) Angle: 36° Field (10%) Angle: 70°

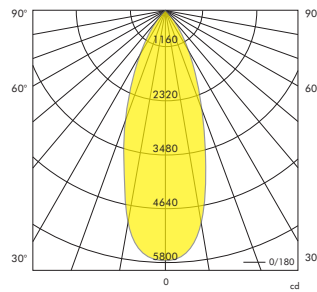

PRODUCT LIST

Article No.	Product Name	Color	LED Lumen	CCT	CRI	LED Power	Reflector	Cutout size
2.11.2062	Pivo Maxi	Grey	3100lm	3000K	>90Ra	24W	36°	Ø 190mm
2.11.2078	Pivo Maxi	White	3100lm	3000K	>90Ra	24W	36°	Ø 190mm
2.11.4183	Pivo Maxi	Black	3100lm	3000K	>90Ra	24W	36°	Ø 190mm
2.11.2091	Pivo Maxi	Grey	5300lm	3000K	>90Ra	42W	36°	Ø 190mm
2.11.2213	Pivo Maxi	White	5300lm	3000K	>90Ra	42W	36°	Ø 190mm
2.11.4184	Pivo Maxi	Black	5300lm	3000K	>90Ra	42W	36°	Ø 190mm

Also available: CRI >80Ra

This is a small selection from our portfolio. Please contact us for a suitable solution for your lighting project.

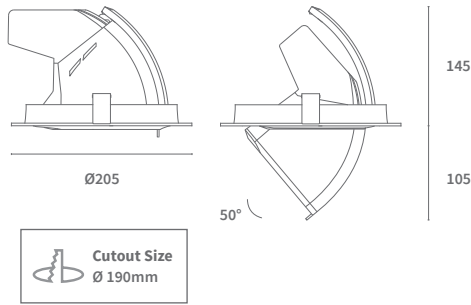

AVAILABLE BEAM ANGLES

Article No.	Description
5.14.0143	Reflector 15° for Pivo Maxi
5.14.0135	Reflector 24° for Pivo Maxi
5.14.0137	Reflector 60° for Pivo Maxi

AVAILABLE DRIVERS

Article No.	Description
-----	Dimmable driver



Pivo Medium

Downlight
Adjustable

Also available

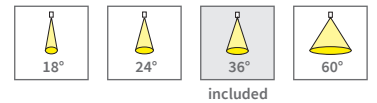

LED Power	17W	24W
CRI	>90Ra	
CCT	3000K	
LED Lumen	2200lm	3100lm
LED Efficacy	129lm/W	129lm/W
LOR	Up to 90%	
Driver	Non-Dimmable Driver (included)	

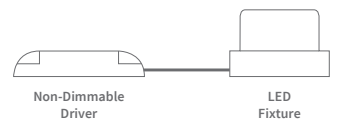

Pivo Medium 24W 3000K

H [m]	[lux]	Beam [Ø cm]	Field [Ø cm]
1	7497	60	120
2	1874	120	250
3	833	180	370
4	469	240	500
5	300	300	620

Beam (50%) Angle: 34° Field (10%) Angle: 64°

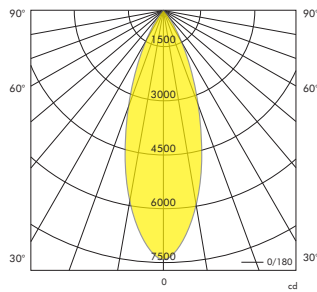

PRODUCT LIST

Article No.	Product Name	Color	LED Lumen	CCT	CRI	LED Power	Reflector	Cutout size
2.11.2596	Pivo Medium	Grey	2200lm	3000K	>90Ra	17W	36°	Ø 154mm
2.11.3542	Pivo Medium	White	2200lm	3000K	>90Ra	17W	36°	Ø 154mm
2.11.4182	Pivo Medium	Black	2200lm	3000K	>90Ra	17W	36°	Ø 154mm
2.11.1494	Pivo Medium	Grey	3100lm	3000K	>90Ra	24W	36°	Ø 154mm
2.11.1495	Pivo Medium	White	3100lm	3000K	>90Ra	24W	36°	Ø 154mm
2.11.1496	Pivo Medium	Black	3100lm	3000K	>90Ra	24W	36°	Ø 154mm

Also available: CRI >80Ra

This is a small selection from our portfolio. Please contact us for a suitable solution for your lighting project.

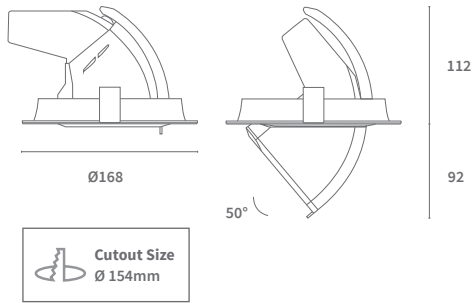

AVAILABLE BEAM ANGLES

Article No.	Description
5.14.0115	Reflector 18° for Pivo Medium
5.14.0116	Reflector 24° for Pivo Medium
5.14.0133	Reflector 60° for Pivo Medium

AVAILABLE DRIVERS

Article No.	Description
-----	Dimmable driver



Pivo Mini

Downlight
Adjustable

Also available

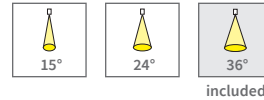

LED Power	17W		
CRI	>90Ra		
CCT	2700K	3000K	3000K PW
LED Lumen	2100lm	2200lm	2200lm
LED Efficacy	123lm/W	129lm/W	129lm/W
LOR	Up to 80%		
Driver	1-10V, trailing and leading edge, 500mA Dimmable Driver (included)		

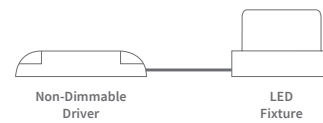

Pivo Mini 17W 3000K

H [m]	[lux]	Beam [Ø cm]	Field [Ø cm]
1	2916	60	140
2	729	130	280
3	324	190	430
4	182	260	570
5	117	320	710

Beam (50%) Angle: 36° Field (10%) Angle: 71°

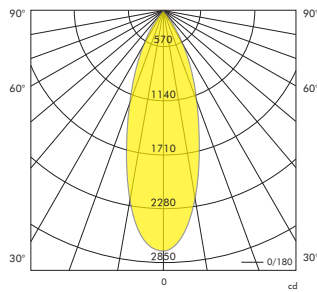

PRODUCT LIST

Article No.	Product Name	Color	LED Lumen	CCT	CRI	LED Power	Reflector	Cutout size
2.11.3645	Pivo Mini	White	2100lm	2700K	>90Ra	17W	36°	Ø 128mm
2.11.3807	Pivo Mini	Black	2100lm	2700K	>90Ra	17W	36°	Ø 128mm
2.11.3371	Pivo Mini	White	2200lm	3000K	>90Ra	17W	36°	Ø 128mm
2.11.3372	Pivo Mini	Black	2200lm	3000K	>90Ra	17W	36°	Ø 128mm
2.11.2915	Pivo Mini	White	2200lm	3000K PW	>90Ra	17W	36°	Ø 128mm
2.11.3023	Pivo Mini	Black	2200lm	3000K PW	>90Ra	17W	36°	Ø 128mm

Also available: CRI >80Ra

This is a small selection from our portfolio. Please contact us for a suitable solution for your lighting project.

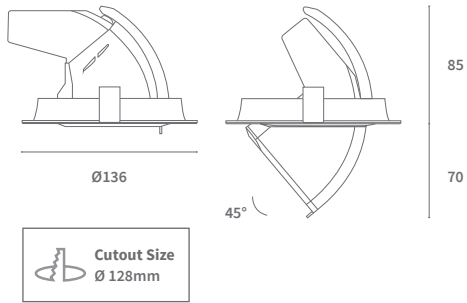

AVAILABLE BEAM ANGLES

Article No.	Description
5.14.0236	Reflector 15° for Pivo Mini
5.14.0237	Reflector 24° for Pivo Mini



Lynx Maxi

Downlight
Adjustable

Also available

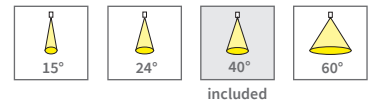

System Power	36W		48W	
CRI	>90Ra			
CCT	3000K	4000K PW	3000K	4000K PW
System Lumen	3331lm	3587lm	4222lm	4548lm
System Efficacy	93lm/W	100lm/W	88lm/W	95lm/W
LOR	Up to 80%			
Driver	Non-dimmable Driver (included)			

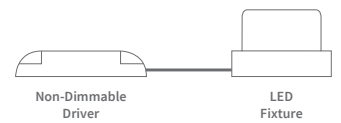

Lynx Maxi 48W 3000K

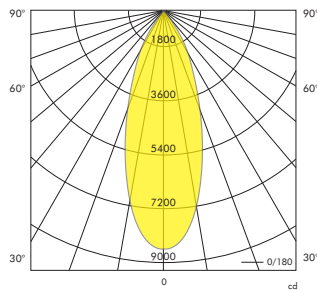
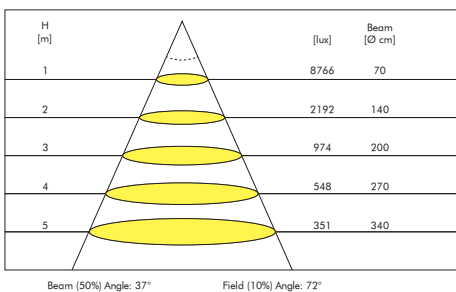

PRODUCT LIST

Article No.	Product Name	Color	System Lumen	CCT	CRI	System Power	Reflector	Cutout size
2.11.4433	Lynx Maxi	White	3331lm	3000K	>90Ra	36W	40°	Ø 175mm
2.11.4434	Lynx Maxi	Black	3587lm	4000K PW	>90Ra	36W	40°	Ø 175mm
2.11.4436	Lynx Maxi	White	4222lm	3000K	>90Ra	48W	40°	Ø 175mm
2.11.4435	Lynx Maxi	Black	4548lm	4000K PW	>90Ra	48W	40°	Ø 175mm

Also available: CRI >80Ra

This is a small selection from our portfolio. Please contact us for a suitable solution for your lighting project.

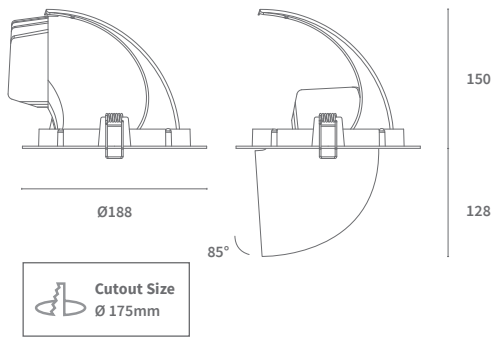

AVAILABLE BEAM ANGLES

Article No.	Description
5.14.0295	Reflector 15° for Lynx Maxi
5.14.0296	Reflector 24° for Lynx Maxi
5.14.0298	Reflector 60° for Lynx Maxi

AVAILABLE DRIVERS

Article No.	Description
-----	Dimmable driver



Lynx Medium

Downlight
Adjustable

Also available

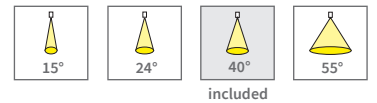

System Power	18W		26W	
CRI	>90Ra			
CCT	3000K	4000K PW	3000K	4000K PW
System Lumen	1807lm	1951lm	2469lm	2665lm
System Efficacy	100lm/W	108lm/W	95lm/W	103lm/W
LOR	Up to 80%			
Driver	Non-Dimmable Driver (included)			

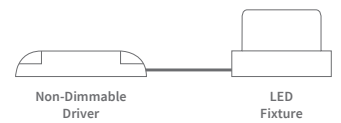

Lynx Medium 26W 3000K

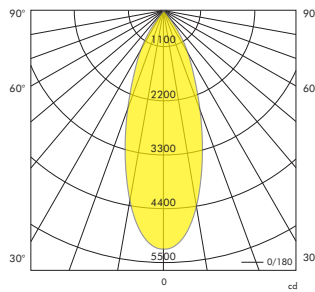
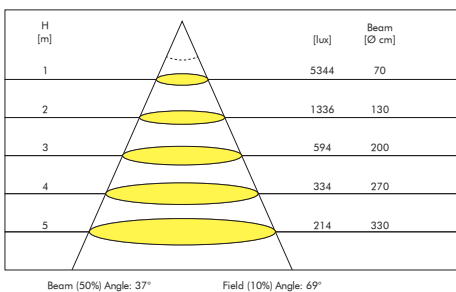

PRODUCT LIST

Article No.	Product Name	Color	System Lumen	CCT	CRI	System Power	Reflector	Cutout size
2.11.4429	Lynx Medium	White	1807lm	3000K	>90Ra	18W	40°	Ø 146mm
2.11.4430	Lynx Medium	White	1951lm	4000K PW	>90Ra	18W	40°	Ø 146mm
2.11.4431	Lynx Medium	Black	2469lm	3000K	>90Ra	26W	40°	Ø 146mm
2.11.4432	Lynx Medium	Black	2665lm	4000K PW	>90Ra	26W	40°	Ø 146mm

Also available: CRI >80Ra
 This is a small selection from our portfolio. Please contact us for a suitable solution for your lighting project.

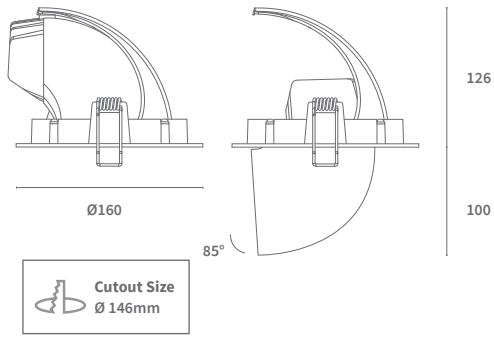

AVAILABLE BEAM ANGLES

Article No.	Description
5.14.0291	Reflector 15° for Lynx Medium
5.14.0292	Reflector 24° for Lynx Medium
5.14.0294	Reflector 55° for Lynx Medium

AVAILABLE DRIVERS

Article No.	Description
-----	Dimmable driver



Wally Maxi

Wallwasher
Adjustable

Also available

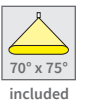

LED Power	42W	
CRI	>90Ra	
CCT	2700K	3000K
LED Lumen	5100lm	5300lm
LED Efficacy	121lm/W	126lm/W
Driver	Non-Dimmable Driver (included)	

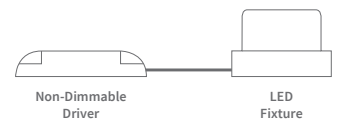

Wally Maxi 42W 3000K

H [m]	[lux]	V-Beam [Ø cm]	H-Beam [Ø cm]
1	2532	150	210
2	633	300	420
3	281	450	630
4	158	600	840
5	101	750	1050

Beam (50%) Vertical: 74°
Beam (50%) Horizontal: 93°
Field (10%) Vertical: 94°
Field (10%) Horizontal: 117°

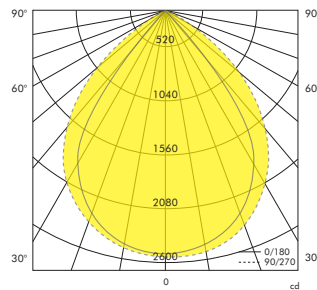

PRODUCT LIST

Article No.	Product Name	Color	LED Lumen	CCT	CRI	LED Power	Reflector	Cutout size
2.11.2953	Wally Maxi	Grey	5100lm	2700K	>90Ra	42W	70° x 75°	225 x 135mm
2.11.3601	Wally Maxi	White	5100lm	2700K	>90Ra	42W	70° x 75°	225 x 135mm
2.11.4185	Wally Maxi	Black	5100lm	2700K	>90Ra	42W	70° x 75°	225 x 135mm
2.11.4186	Wally Maxi	Grey	5300lm	3000K	>90Ra	42W	70° x 75°	225 x 135mm
2.11.3414	Wally Maxi	White	5300lm	3000K	>90Ra	42W	70° x 75°	225 x 135mm
2.11.4187	Wally Maxi	Black	5300lm	3000K	>90Ra	42W	70° x 75°	225 x 135mm

Also available: CRI >80Ra

This is a small selection from our portfolio. Please contact us for a suitable solution for your lighting project.

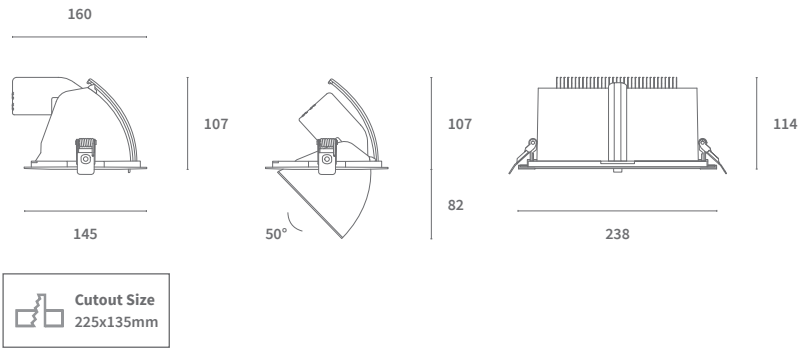

AVAILABLE DRIVERS

Article No.	Description
-----	DALI Dimmable Driver
-----	1-10V Dimmable Driver



Wally Medium

Wallwasher
Adjustable

Also available

- HIGH CRI >90Ra
- FASHION modules
- FOOD modules
- CUSTOM specs



LED Power	24W	
CRI	>90Ra	
CCT	2700K	3000K
LED Lumen	2950lm	3100lm
LED Efficacy	123lm/W	129lm/W
Driver	Non-Dimmable Driver (included)	

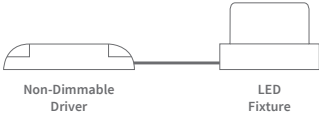

Wally Medium 24W 3000K

H [m]	[lux]	V-Beam [Ø cm]	H-Beam [Ø cm]
1	2020	160	210
2	505	320	430
3	224	480	640
4	126	640	860
5	81	810	1070

Beam (50%) Vertical: 78°
Beam (50%) Horizontal: 94°
Field (10%) Vertical: 98°
Field (10%) Horizontal: 115°

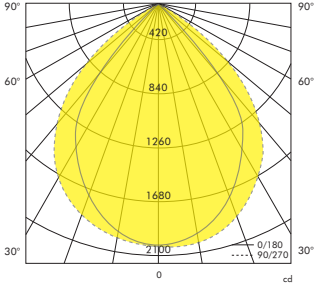

PRODUCT LIST

Article No.	Product Name	Color	LED Lumen	CCT	CRI	LED Power	Reflector	Cutout size
2.11.2255	Wally Medium	Grey	2950lm	2700K	>90Ra	24W	78° x 100°	218 x 125mm
2.11.2999	Wally Medium	White	2950lm	3000K	>90Ra	24W	78° x 100°	218 x 125mm
2.11.2217	Wally Medium	Grey	3100lm	2700K	>90Ra	24W	78° x 100°	218 x 125mm
2.11.2219	Wally Medium	White	3100lm	3000K	>90Ra	24W	78° x 100°	218 x 125mm

Also available: CRI >80Ra

This is a small selection from our portfolio. Please contact us for a suitable solution for your lighting project.

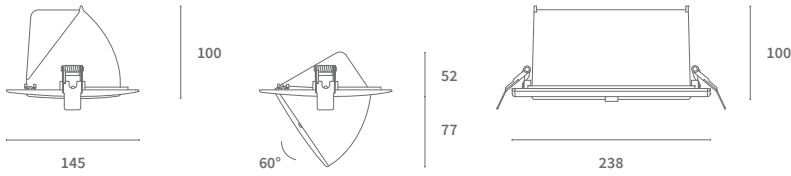

AVAILABLE DRIVERS

Article No.	Description
-----	DALI Dimmable Driver
-----	1-10V Dimmable Driver



Globo

Spot Light Fixed & Adjustable Round



LED Power	3W (12V @ 350mA)	
CRI	>80Ra	
CCT	2700K	3200K
LED Lumen	Up to 132lm	
LED Efficacy	Up to 44lm/W	
LOR	85%	
Driver	12V DC Max. 700mA Driver (not included)	



lens included

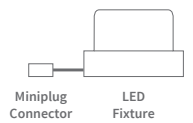

2m cable with Miniplug (included)

Globo 3W 3000K

H [m]	[lux]	Beam [Ø cm]	Field [Ø cm]
1	1154	40	70
2	288	70	130
3	128	110	200
4	72	140	270
5	46	180	340

Beam (50%) Angle: 20°

Field (10%) Angle: 37°

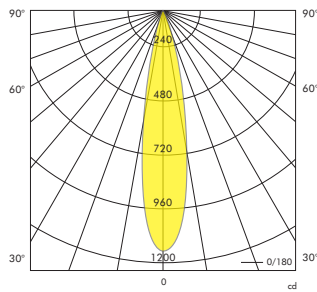

PRODUCT LIST

Article No.	Product Name	Color	LED Lumen	CCT	CRI	LED Power	Lens	Cutout size
2.11.0637	Globo Fixed	Aluminium	132lm	2700K	>80Ra	Max. 3W	20°	Ø 35mm
2.11.0623	Globo Fixed	Aluminium	132lm	3200K	>80Ra	Max. 3W	20°	Ø 35mm
2.11.0638	Globo Adjustable	Aluminium	132lm	2700K	>80Ra	Max. 3W	20°	Ø 42mm
2.11.0624	Globo Adjustable	Aluminium	132lm	3200K	>80Ra	Max. 3W	20°	Ø 42mm

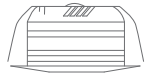

25

Ø 42

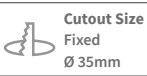

Cutout Size
Fixed
Ø 35mm

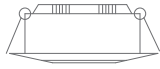

21

Ø 50



Cutout Size
Adjustable
Ø 42mm

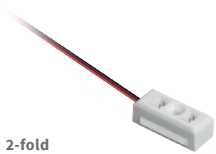

2-fold

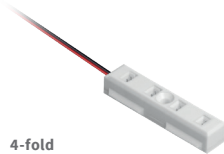

4-fold

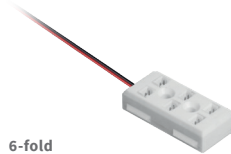

6-fold

Bridge



Miniplug



DISTRIBUTOR

Article No.	Product Name	Cable Length	Connections	Bridge Number	Ends
3.01.0078	Miniplug Distributor	2m	2-fold	1x bridge	miniplug
3.01.0079	Miniplug Distributor	2m	2-fold	1x bridge	stripped cable
3.01.0080	Miniplug Distributor	4m	2-fold	1x bridge	miniplug
3.01.0081	Miniplug Distributor	2m	4-fold	2x bridge	miniplug
3.01.0082	Miniplug Distributor	2m	4-fold	2x bridge	stripped cable
3.01.0083	Miniplug Distributor	2m	6-fold	3x bridge	miniplug
3.01.0084	Miniplug Distributor	2m	6-fold	3x bridge	stripped cable

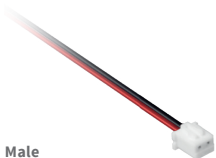

Male



Female

CONNECTION CABLE

Article No.	Product Name	Wire Size	Lenght	Color	Ends
5.03.0473	Miniplug Connection Cable	0.34mm ²	2m	Black	Male / Female
5.03.0474	Miniplug Connection Cable	0.34mm ²	5m	Black	Male / Female
5.03.0475	Miniplug Connection Cable	0.34mm ²	6m	Black	Male / Female

AVAILABLE DRIVERS

Article No.	Product Name	Max. Load	Globo	Dimmable
3.10.0341	LED Driver PLKE3030 CV 12V 8.4W	700mA	1 - 2 Spots (3W, 12V @ 350mA)	Primary Dimmable
3.10.0124	LED Driver PLP303	700mA	1 - 3 Spots (3W)	-
3.10.0062	LED Driver PD309	700mA	3 - 9 Spots (3W)	-



Accent II

Cabinet Spot
Fixed Round



included

LED Power	3W (12V @ 350mA)
CRI	>80Ra
CCT	3000K
LED Lumen	Up to 240lm
LED Efficacy	Up to 80lm/W
Driver	12V DC Max. 350mA Driver (not included)

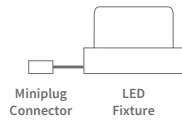

Miniplug Connector LED Fixture



2m cable with Miniplug (included)

Accent II 3W 3000K

H [m]	[lux]	Beam [Ø cm]	Field [Ø cm]
1	98	260	940
2	25	520	1870
3	11	780	2810
4	6	1040	3750
5	4	1300	4680

Beam (50%) Angle: 105°

Field (10%) Angle: 156°

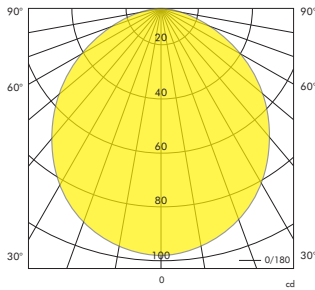

PRODUCT LIST

Article No.	Product Name	Color	LED Lumen	CCT	CRI	LED Power	Lens	Cutout size
2.11.1127	Accent Two	Brushed Aluminium	240lm	3000K	>80Ra	Max. 3W	90°	Ø 55mm
2.11.1591	Accent Two	White	240lm	3000K	>80Ra	Max. 3W	90°	Ø 55mm



2.01.0802
(not included)



2.01.0803
(not included)



Ø 72



14

ALSO AVAILABLE

Article No.	Description	Color	Size
2.01.0802	Frame for Accent Two	Brushed Aluminium	Ø73 H:17
2.01.0803	Frame for Accent Two	White	Ø73 H:17

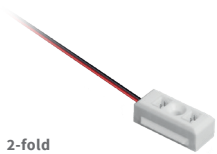

2-fold

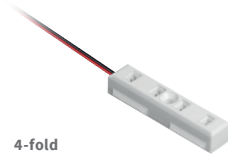

4-fold

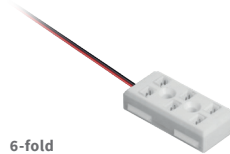

6-fold

Bridge



Miniplug



DISTRIBUTOR

Article No.	Product Name	Cable Length	Connections	Bridge Number	Ends
3.01.0078	Miniplug Distributor	2m	2-fold	1x bridge	miniplug
3.01.0079	Miniplug Distributor	2m	2-fold	1x bridge	stripped cable
3.01.0080	Miniplug Distributor	4m	2-fold	1x bridge	miniplug
3.01.0081	Miniplug Distributor	2m	4-fold	2x bridge	miniplug
3.01.0082	Miniplug Distributor	2m	4-fold	2x bridge	stripped cable
3.01.0083	Miniplug Distributor	2m	6-fold	3x bridge	miniplug
3.01.0084	Miniplug Distributor	2m	6-fold	3x bridge	stripped cable



Male



Female

CONNECTION CABLE

Article No.	Product Name	Wire Size	Lenght	Color	Ends
5.03.0473	Miniplug Connection Cable	0.34mm ²	2m	Black	Male / Female
5.03.0474	Miniplug Connection Cable	0.34mm ²	5m	Black	Male / Female
5.03.0475	Miniplug Connection Cable	0.34mm ²	6m	Black	Male / Female

AVAILABLE DRIVERS

Article No.	Product Name	Max. Load	Accent II	Dimmable
3.10.0003	LED Driver DPL110E	350mA	1 - 9 Spots (3W, 12V @ 350mA)	-
3.10.0331	LED Driver PLKE1060 CV 12V 8.4W	350mA	2 - 3 Spots (3W)	Primary Dimmable
3.10.0060	LED Driver PBOX30	350mA	3 - 27 Spots (3W)	-

Recessed Panels



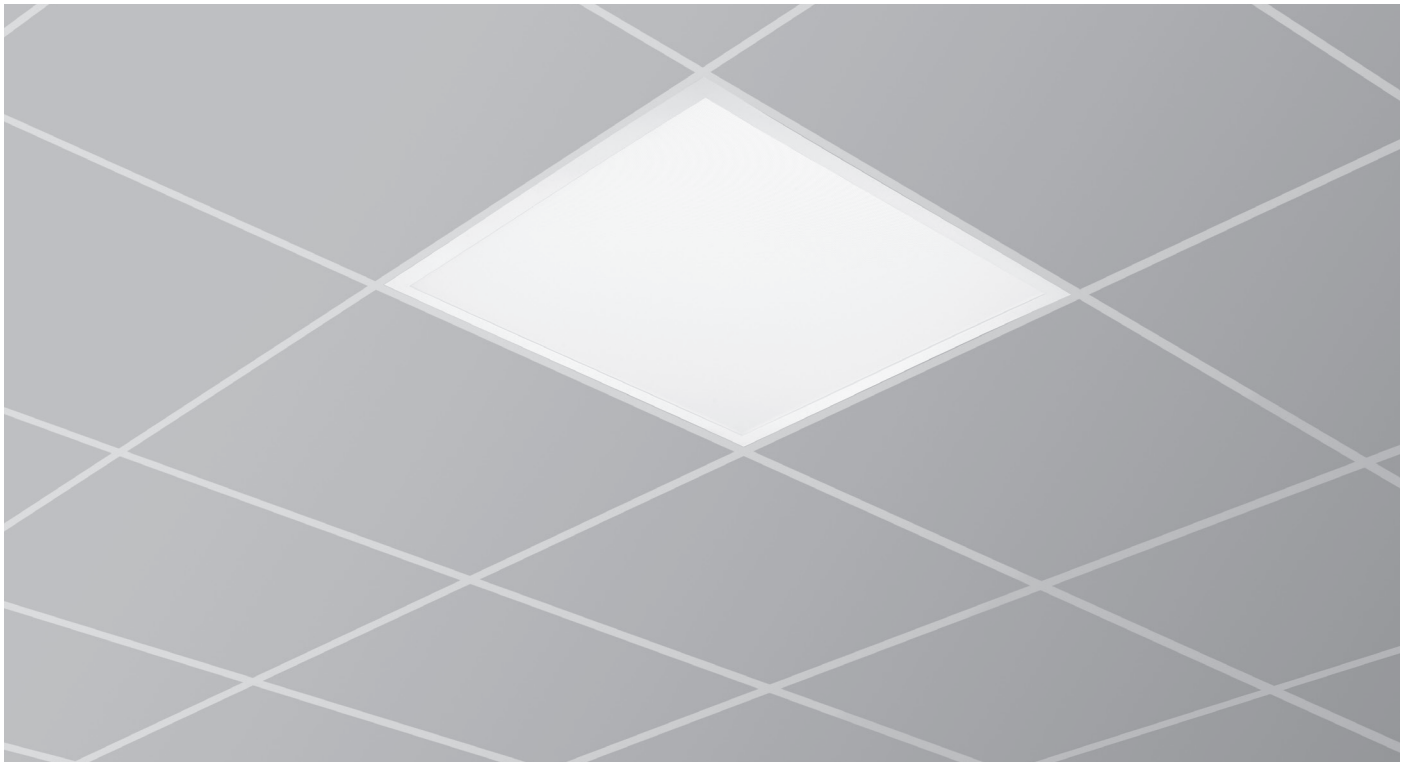

Valo

Recessed Panel

LED

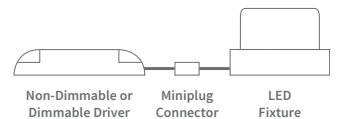

UGR	High Output (UGR <22)						High Comfort (UGR <19)					
Size	595 x 595 x 10mm	622 x 622 x 10mm		295 x 1195 x 10mm		595 x 595 x 10mm	622 x 622 x 10mm		295 x 1195 x 10mm			
System Power	± 25W - Non-Dimmable @ 700mA / ± 27W - DALI-Dimmable @ 700mA / ± 35W - Non-Dimmable @ 900mA / ± 35W - DALI-Dimmable @ 900mA											
CRI	>80Ra											
CCT	3000K	4000K	3000K	4000K	3000K	4000K	3000K	4000K	3000K	4000K	3000K	4000K
System Lumen Non-Dimmable @ 700mA	3015lm	3224lm	2995lm	3240lm	3031lm	3149lm	2800lm	3119lm	2897lm	3188lm	2771lm	2997lm
System Efficacy Non-Dimmable @ 700mA	119lm/W	127lm/W	118lm/W	128lm/W	121lm/W	125lm/W	110lm/W	124lm/W	114lm/W	126lm/W	111lm/W	120lm/W
System Lumen DALI-Dimmable @ 700mA	3100lm	3301lm	3085lm	3342lm	3128lm	3249lm	2891lm	3219lm	2985lm	3283lm	2867lm	3094lm
System Efficacy DALI-Dimmable @ 700mA	116lm/W	125lm/W	115lm/W	125lm/W	118lm/W	123lm/W	108lm/W	121lm/W	112lm/W	123lm/W	109lm/W	118lm/W
System Lumen Non-Dimmable @ 900mA	4015lm	4291lm	3959lm	4309lm	4015lm	4141lm	3609lm	4132lm	3843lm	4184lm	3687lm	3942lm
System Efficacy Non-Dimmable @ 900mA	115lm/W	123lm/W	114lm/W	125lm/W	118lm/W	122lm/W	112lm/W	120lm/W	110lm/W	121lm/W	108lm/W	115lm/W
System Lumen DALI-Dimmable @ 900mA	3946lm	4231lm	3934lm	4257lm	4000lm	4159lm	3585lm	4084lm	3784lm	4164lm	3637lm	3491lm
System Efficacy DALI-Dimmable @ 900mA	113lm/W	121lm/W	113lm/W	123lm/W	116lm/W	121lm/W	103lm/W	118lm/W	108lm/W	119lm/W	106lm/W	115lm/W
Cover	PMMA Light Guide Plate + Opal Diffuser						PMMA Light Guide Plate + Prismatic Diffuser					
Driver	Non-Dimmable or Dimmable Driver (included)											
	Available on request											

PANELS							
Article No.	Product Name	Color	CCT	CRI	Driver	Cover	Size
2.17.3219	Valo High Output (UGR<22)	White	3000K	>80Ra	700mA Non-dimmable	PMMA Light Guide Plate + Opal Diffuser	595 x 595 x 10mm
2.17.3223	Valo High Output (UGR<22)	White	3000K	>80Ra	700mA DALI-dimmable	PMMA Light Guide Plate + Opal Diffuser	595 x 595 x 10mm
2.17.3221	Valo High Output (UGR<22)	White	3000K	>80Ra	900mA Non-dimmable	PMMA Light Guide Plate + Opal Diffuser	595 x 595 x 10mm
2.17.3225	Valo High Output (UGR<22)	White	3000K	>80Ra	900mA DALI-dimmable	PMMA Light Guide Plate + Opal Diffuser	595 x 595 x 10mm
2.17.3220	Valo High Output (UGR<22)	White	4000K	>80Ra	700mA Non-dimmable	PMMA Light Guide Plate + Opal Diffuser	595 x 595 x 10mm
2.17.3224	Valo High Output (UGR<22)	White	4000K	>80Ra	700mA DALI-dimmable	PMMA Light Guide Plate + Opal Diffuser	595 x 595 x 10mm
2.17.3222	Valo High Output (UGR<22)	White	4000K	>80Ra	900mA Non-dimmable	PMMA Light Guide Plate + Opal Diffuser	595 x 595 x 10mm
2.17.3226	Valo High Output (UGR<22)	White	4000K	>80Ra	900mA DALI-dimmable	PMMA Light Guide Plate + Opal Diffuser	595 x 595 x 10mm
2.17.3235	Valo High Output (UGR<22)	White	3000K	>80Ra	700mA Non-dimmable	PMMA Light Guide Plate + Opal Diffuser	622 x 622 x 10mm
2.17.3239	Valo High Output (UGR<22)	White	3000K	>80Ra	700mA DALI-dimmable	PMMA Light Guide Plate + Opal Diffuser	622 x 622 x 10mm
2.17.3237	Valo High Output (UGR<22)	White	3000K	>80Ra	900mA Non-dimmable	PMMA Light Guide Plate + Opal Diffuser	622 x 622 x 10mm
2.17.3241	Valo High Output (UGR<22)	White	3000K	>80Ra	900mA DALI-dimmable	PMMA Light Guide Plate + Opal Diffuser	622 x 622 x 10mm
2.17.3236	Valo High Output (UGR<22)	White	4000K	>80Ra	700mA Non-dimmable	PMMA Light Guide Plate + Opal Diffuser	622 x 622 x 10mm
2.17.3240	Valo High Output (UGR<22)	White	4000K	>80Ra	700mA DALI-dimmable	PMMA Light Guide Plate + Opal Diffuser	622 x 622 x 10mm
2.17.3238	Valo High Output (UGR<22)	White	4000K	>80Ra	900mA Non-dimmable	PMMA Light Guide Plate + Opal Diffuser	622 x 622 x 10mm
2.17.3242	Valo High Output (UGR<22)	White	4000K	>80Ra	900mA DALI-dimmable	PMMA Light Guide Plate + Opal Diffuser	622 x 622 x 10mm
2.17.3251	Valo High Output (UGR<22)	White	3000K	>80Ra	700mA Non-dimmable	PMMA Light Guide Plate + Opal Diffuser	295 x 1195 x 10mm
2.17.3255	Valo High Output (UGR<22)	White	3000K	>80Ra	700mA DALI-dimmable	PMMA Light Guide Plate + Opal Diffuser	295 x 1195 x 10mm
2.17.3253	Valo High Output (UGR<22)	White	3000K	>80Ra	900mA Non-dimmable	PMMA Light Guide Plate + Opal Diffuser	295 x 1195 x 10mm
2.17.3257	Valo High Output (UGR<22)	White	3000K	>80Ra	900mA DALI-dimmable	PMMA Light Guide Plate + Opal Diffuser	295 x 1195 x 10mm
2.17.3252	Valo High Output (UGR<22)	White	4000K	>80Ra	700mA Non-dimmable	PMMA Light Guide Plate + Opal Diffuser	295 x 1195 x 10mm
2.17.3256	Valo High Output (UGR<22)	White	4000K	>80Ra	700mA DALI-dimmable	PMMA Light Guide Plate + Opal Diffuser	295 x 1195 x 10mm
2.17.3254	Valo High Output (UGR<22)	White	4000K	>80Ra	900mA Non-dimmable	PMMA Light Guide Plate + Opal Diffuser	295 x 1195 x 10mm
2.17.3258	Valo High Output (UGR<22)	White	4000K	>80Ra	900mA DALI-dimmable	PMMA Light Guide Plate + Opal Diffuser	295 x 1195 x 10mm
2.17.3211	Valo High Comfort (UGR<19)	White	3000K	>80Ra	700mA Non-dimmable	PMMA Light Guide Plate + Prismatic Diffuser	595 x 595 x 10mm
2.17.3215	Valo High Comfort (UGR<19)	White	3000K	>80Ra	700mA DALI-dimmable	PMMA Light Guide Plate + Prismatic Diffuser	595 x 595 x 10mm
2.17.3213	Valo High Comfort (UGR<19)	White	3000K	>80Ra	900mA Non-dimmable	PMMA Light Guide Plate + Prismatic Diffuser	595 x 595 x 10mm
2.17.3217	Valo High Comfort (UGR<19)	White	3000K	>80Ra	900mA DALI-dimmable	PMMA Light Guide Plate + Prismatic Diffuser	595 x 595 x 10mm
2.17.3212	Valo High Comfort (UGR<19)	White	4000K	>80Ra	700mA Non-dimmable	PMMA Light Guide Plate + Prismatic Diffuser	595 x 595 x 10mm
2.17.3216	Valo High Comfort (UGR<19)	White	4000K	>80Ra	700mA DALI-dimmable	PMMA Light Guide Plate + Prismatic Diffuser	595 x 595 x 10mm
2.17.3214	Valo High Comfort (UGR<19)	White	4000K	>80Ra	900mA Non-dimmable	PMMA Light Guide Plate + Prismatic Diffuser	595 x 595 x 10mm
2.17.3218	Valo High Comfort (UGR<19)	White	4000K	>80Ra	900mA DALI-dimmable	PMMA Light Guide Plate + Prismatic Diffuser	595 x 595 x 10mm
2.17.3228	Valo High Comfort (UGR<19)	White	4000K	>80Ra	700mA Non-dimmable	PMMA Light Guide Plate + Prismatic Diffuser	622 x 622 x 10mm
2.17.3232	Valo High Comfort (UGR<19)	White	4000K	>80Ra	700mA DALI-dimmable	PMMA Light Guide Plate + Prismatic Diffuser	622 x 622 x 10mm
2.17.3230	Valo High Comfort (UGR<19)	White	4000K	>80Ra	900mA Non-dimmable	PMMA Light Guide Plate + Prismatic Diffuser	622 x 622 x 10mm
2.17.3234	Valo High Comfort (UGR<19)	White	4000K	>80Ra	900mA DALI-dimmable	PMMA Light Guide Plate + Prismatic Diffuser	622 x 622 x 10mm

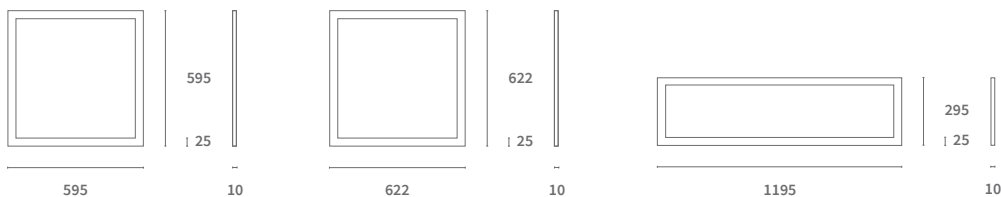



Suave

Daylight
is the light
that we, as

humans, like best. People feel more comfortable in natural light,
thus increasing our performance and concentration.

Just as daylight, the Suave inlay fixture has a beautiful balance
between direct and indirect light. The Suave luminaire has an
even distribution of lighting, this is the reason why the Suave is
perfect for office environments.

The Suave brings the outside, inside.





Suave

Recessed Panel LED



UGR	UGR <19 @ max. 1050mA					
Size	595*595mm					
System Power	33W @ 850mA	38W @ 950mA		45W @ 1150mA		
CRI	>80Ra					
CCT	3000K	4000K	3000K	4000K	3000K	4000K
System Lumen	3505lm	3852lm	3919lm	4307lm	4554lm	5004lm
System Efficacy	106lm/W	117lm/W	103lm/W	113lm/W	101lm/W	111lm/W
LOR	Up to 80%					
Driver	Not included, available options in driver list					
Cover	PMMA Opal Diffuser					

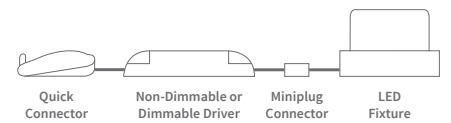

Suave 45W 4000K

H [m]	[lux]	Beam [Ø cm]	Field [Ø cm]
1	2676	192	682
2	669	385	1363
3	297	577	2045
4	167	769	2726
5	107	962	3408

Beam (50%) Angle: 88° Field (10%) Angle: 147°

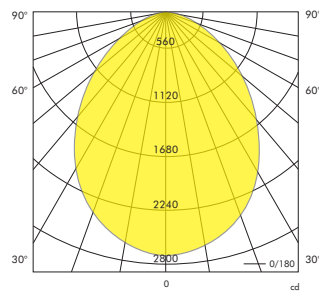

PANELS

Article No.	Product Name	Color	System Lumen	CCT	CRI	System Power	Cover	Size
2.11.3967	Suave recessed LED panel	White	Up to 4554lm	3000K	>80Ra	Up to 45W	Frosted Opal	595*595mm
2.11.3968	Suave recessed LED panel	White	Up to 5004lm	4000K	>80Ra	Up to 45W	Frosted Opal	595*595mm



AVAILABLE DRIVERS

Article No.	Product Name	Output Current	Maximum Driver Power	Dimmable
3.10.0477	LED driver with primary and secondary quick connector for LED panel Suave	850mA	36W	-
3.10.0478	LED driver with primary and secondary quick connector for LED panel Suave	950mA	40W	-
3.10.0479	LED driver with primary and secondary quick connector for LED panel Suave	1150mA	48W	-
3.10.0480	LED driver OTE50 with primary and secondary quick connector for LED panel Suave	800mA	43W	-
3.10.0481	LED driver OTE50 with primary and secondary quick connector for LED panel Suave	925mA	50W	-
3.10.0482	LED driver OTE50 with primary and secondary quick connector for LED panel Suave	1150mA	41W	-
3.10.0483	LED driver OTi50 with primary and secondary quick connector for LED panel Suave	800mA	43W	DALI
3.10.0484	LED driver OTi50 with primary and secondary quick connector for LED panel Suave	950mA	51W	DALI
3.10.0485	LED driver OTi50 with primary and secondary quick connector for LED panel Suave	1150mA	55W	DALI
3.10.0495	LED driver with primary and secondary quick connector for LED panel Suave	920mA	40W	1-10V

Pendants



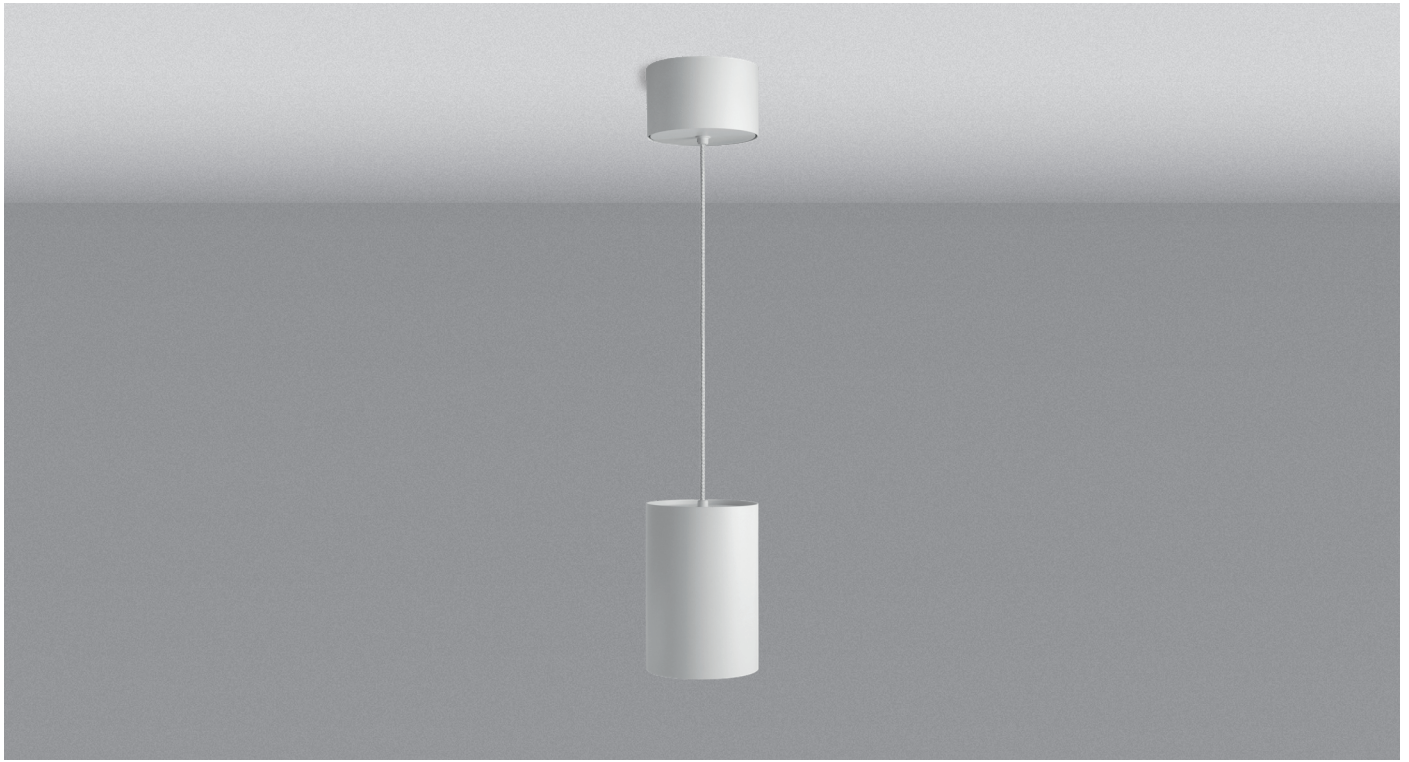

Vide

Pendant



LED Power	20W		
CRI	>95Ra		>90Ra
CCT	2700K	3000K	4000K
LED Lumen	1300lm	1350lm	1400lm
LED Efficacy	65lm/W	67lm/W	70lm/W
LOR	>85%		
Driver	500mA Dimmable Driver (included)		

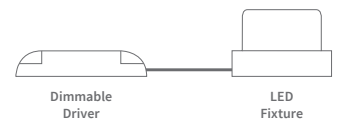

Vide 20W 3000K

H [m]	[lux]	Beam [Ø cm]	Field [Ø cm]
1	3335	65	117
2	834	129	235
3	371	194	352
4	208	258	469
5	133	323	587

Beam (50%) Angle: 36° Field (10%) Angle: 61°

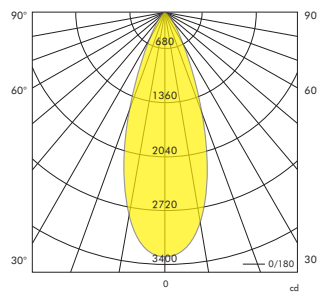

PRODUCT LIST

Article No.	Product Name	Housing Color	Ring Color	LED Lumen	CCT	CRI	LED Power	Reflector
2.06.0353	Vide Pendant	Grey	Grey	1300lm	2700K	>95Ra	20W	40°
2.06.0398	Vide Pendant	White	White	1300lm	2700K	>95Ra	20W	40°
2.06.0443	Vide Pendant	Black	Black	1300lm	2700K	>95Ra	20W	40°
2.06.0356	Vide Pendant	Grey	Grey	1350lm	3000K	>95Ra	20W	40°
2.06.0401	Vide Pendant	White	White	1350lm	3000K	>95Ra	20W	40°
2.06.0359	Vide Pendant	Grey	Grey	1400lm	4000K	>90Ra	20W	40°
2.06.0404	Vide Pendant	White	White	1400lm	4000K	>90Ra	20W	40°
2.06.0449	Vide Pendant	Black	Black	1400lm	4000K	>90Ra	20W	40°

Also available: other color combinations

This is a small selection from our portfolio. Please contact us for a suitable solution for your lighting project.

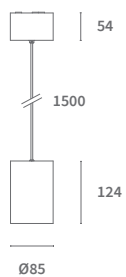

AVAILABLE BEAM ANGLES

Article No.	Description
5.14.0210	Reflector 15° for Vide Track
5.14.0211	Reflector 25° for Vide Track

ALSO AVAILABLE

Article No.	Description
2.01.0927	Gold Ring for Vide Track
2.01.0928	Grey Ring for Vide Track
2.01.0929	White Ring for Vide Track
2.01.0930	Black Ring for Vide Track



Discus

Pendant Panel

Round



System Power	58W	
CRI	>80Ra	
CCT	3000K	4000K
System Lumen	5600lm	6000lm
System Efficacy	96lm/W	103lm/W
LOR	>70%	
Driver	Non-Dimmable Tridonic Driver @ 1400mA (included)	
Cover	PMMA Opal Diffuser	

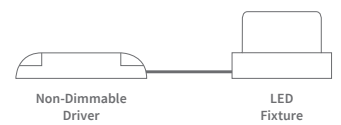

**Pendant mounting set,
cable length 1.5m
(Included)**

Discus 58W 3000K

H [m]	[lux]	Beam [Ø cm]	Field [Ø cm]
1	2085	309	1450
2	521	618	2900
3	232	927	4351
4	130	1235	5801
5	83	1544	7251

Beam (50%) Angle: 114° Field (10%) Angle: 164°

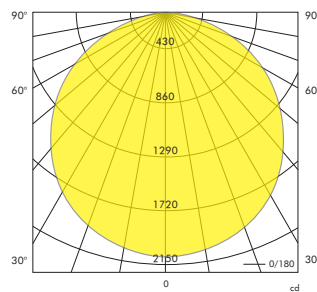

PRODUCT LIST

Article No.	Product Name	Color	System Lumen	CCT	CRI	System Power	Cover	Diameter
2.06.0539	Discus	White	5600lm	3000K	>80Ra	58W	PMMA Opal Diffuser	610mm
2.06.0540	Discus	White	6000lm	4000K	>80Ra	58W	PMMA Opal Diffuser	610mm
2.06.0544	Discus (DALI Dimmable)	White	5600lm	3000K	>80Ra	58W	PMMA Opal Diffuser	610mm
2.06.0545	Discus (DALI Dimmable)	White	6000lm	4000K	>80Ra	58W	PMMA Opal Diffuser	610mm

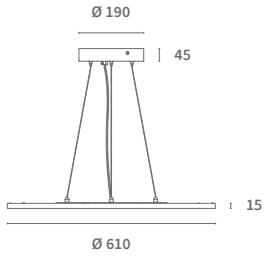





Ozola

The Ozola, the new generation Rondella. Ozola's geometric design guarantees powerful appearance illumination and atmosphere. With its various mounting options and extensive range of sizes, the Ozola blends perfectly in every surrounding.

- ▶ Available in 4 sizes
 - ▶ Available in 3 colours (black, grey and white).
 - ▶ Variable colour temperature 3000/3500/4000K
 - ▶ Regulate the output with a DIP switch on top of the luminaire 50/75/100%
- ▶ Dimmable



Ozola

Pendant
LED

Switchable: 3000K / 3500K / 4000K

Adjustable light output: 100% / 75% / 50%



Size	480mm			600mm			900mm			1200mm		
System Power	40W			57W			92W			150W		
CRI	>80Ra											
CCT	3000K	3500K	4000K	3000K	3500K	4000K	3000K	3500K	4000K	3000K	3500K	4000K
System Lumen	3330lm	3480lm	3510lm	5220lm	5540lm	5575lm	7540lm	7850lm	7900lm	14450lm	14900lm	14630lm
System Efficacy	83lm/W	87lm/W	87lm/W	91lm/W	97lm/W	97lm/W	82lm/W	85lm/W	86lm/W	96lm/W	99lm/W	98lm/W
Driver	DALI Dimmable Driver (included)											
Accessories	Pendant set (not included)											

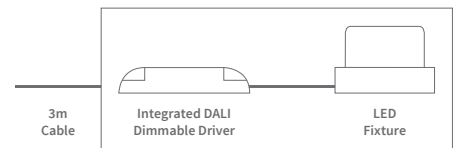
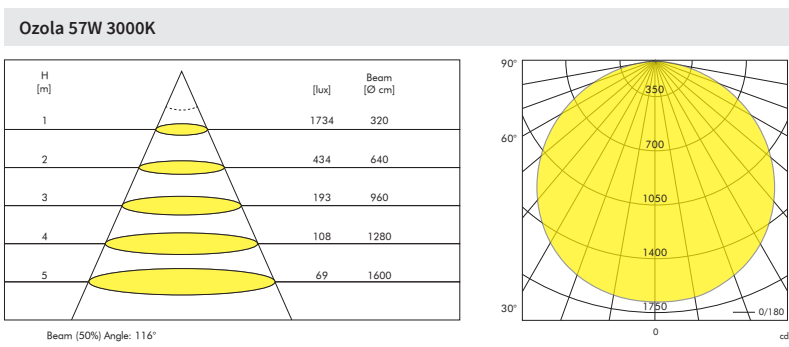

PRODUCT LIST

Article No.	Product Name	Size	Color	System Lumen	CCT	CRI	System Power
2.17.2633	Ozola	480mm	Grey	3330lm / 3480lm / 3510lm	3000K / 3500K / 4000K	>80Ra	40W
2.17.2634	Ozola	480mm	White	3330lm / 3480lm / 3510lm	3000K / 3500K / 4000K	>80Ra	40W
2.17.2635	Ozola	480mm	Black	3330lm / 3480lm / 3510lm	3000K / 3500K / 4000K	>80Ra	40W
2.17.2636	Ozola	600mm	Grey	5220lm / 5540lm / 5575lm	3000K / 3500K / 4000K	>80Ra	57W
2.17.2637	Ozola	600mm	White	5220lm / 5540lm / 5575lm	3000K / 3500K / 4000K	>80Ra	57W
2.17.2638	Ozola	600mm	Black	5220lm / 5540lm / 5575lm	3000K / 3500K / 4000K	>80Ra	57W
2.17.2639	Ozola	900mm	Grey	7540lm / 7850lm / 7900lm	3000K / 3500K / 4000K	>80Ra	92W
2.17.2640	Ozola	900mm	White	7540lm / 7850lm / 7900lm	3000K / 3500K / 4000K	>80Ra	92W
2.17.2641	Ozola	900mm	Black	7540lm / 7850lm / 7900lm	3000K / 3500K / 4000K	>80Ra	92W
2.17.2642	Ozola	1200mm	Grey	14450lm / 14900lm / 14630lm	3000K / 3500K / 4000K	>80Ra	150W
2.17.2643	Ozola	1200mm	White	14450lm / 14900lm / 14630lm	3000K / 3500K / 4000K	>80Ra	150W
2.17.2644	Ozola	1200mm	Black	14450lm / 14900lm / 14630lm	3000K / 3500K / 4000K	>80Ra	150W

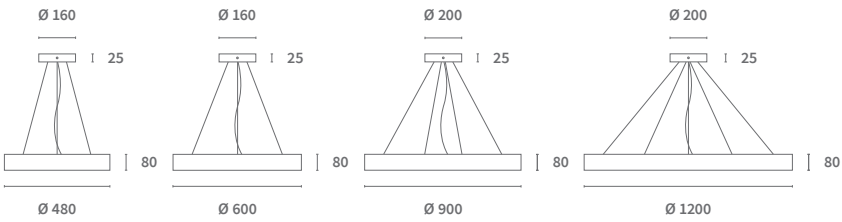

AVAILABLE PENDANTS SETS

Article No.	Description	Color	Article No.	Description	Color
2.01.1208	Pendant set for Ozola 480mm & 600mm	Grey	2.01.1214	Pendant set for Ozola 1200mm	Grey
2.01.1209	Pendant set for Ozola 480mm & 600mm	White	2.01.1215	Pendant set for Ozola 1200mm	White
2.01.1210	Pendant set for Ozola 480mm & 600mm	Black	2.01.1216	Pendant set for Ozola 1200mm	Black
2.01.1211	Pendant set for Ozola 900mm	Grey			
2.01.1212	Pendant set for Ozola 900mm	White			
2.01.1213	Pendant set for Ozola 900mm	Black	See page 138	The Ozola is also available as a surface mounted variant.	



Asta Pendant

Downlight

Kardan Square

Also available

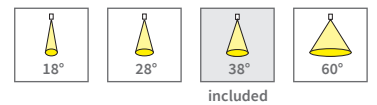
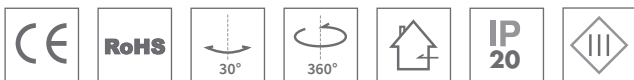

LED Power	24W		40W	
CRI	>80Ra			
CCT	3000K	4000K	3000K	4000K
LED Lumen	3700lm	3850lm	5600lm	5900lm
LED Efficacy	154lm/W	160lm/W	140lm/W	147lm/W
LOR	Up to 85%			
Driver	Non-Dimmable Driver (included in downlight module)			

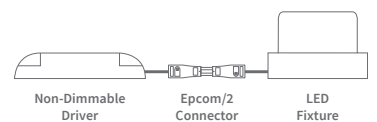

* Product information per spot head.



Ceiling Box for driver
(not included)

Asta 40W 3000K (per downlight module)

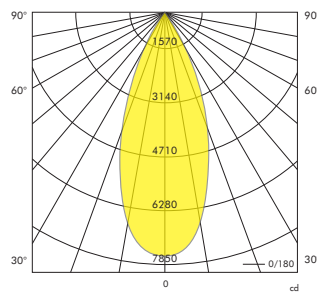
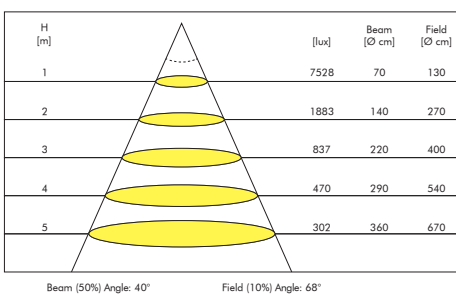

Ceiling Mounting Set
(included)

DOWNLIGHT MODULE							
Article No.	Product Name	Color	LED Lumen	CCT	CRI	LED Power	Reflector
2.06.0463/2.06.0464	Asta Pendant 2-frame 1-light	Grey	3700lm/3850lm	3000K/4000K	>80Ra	24W	38°
2.06.0469/2.06.0470	Asta Pendant 2-frame 1-light	White	3700lm/3850lm	3000K/4000K	>80Ra	24W	38°
2.06.0475/2.06.0476	Asta Pendant 2-frame 1-light	Black	3700lm/3850lm	3000K/4000K	>80Ra	24W	38°
2.06.0466/2.06.0467	Asta Pendant 2-frame 1-light	Grey	5600lm/5900lm	3000K/4000K	>80Ra	40W	38°
2.06.0472/2.06.0473	Asta Pendant 2-frame 1-light	White	5600lm/5900lm	3000K/4000K	>80Ra	40W	38°
2.06.0478/2.06.0479	Asta Pendant 2-frame 1-light	Black	5600lm/5900lm	3000K/4000K	>80Ra	40W	38°
2.06.0481/2.06.0482	Asta Pendant 2-frame 2-light	Grey	2* 3700lm/2* 3850lm	3000K/4000K	>80Ra	2* 24W	38°
2.06.0487/2.06.0488	Asta Pendant 2-frame 2-light	White	2* 3700lm/2* 3850lm	3000K/4000K	>80Ra	2* 24W	38°
2.06.0493/2.06.0494	Asta Pendant 2-frame 2-light	Black	2* 3700lm/2* 3850lm	3000K/4000K	>80Ra	2* 24W	38°
2.06.0484/2.06.0485	Pendant Asta 2-frame 2-light	Grey	2* 5600lm/2* 5900lm	3000K/4000K	>80Ra	2* 40W	38°
2.06.0490/2.06.0491	Pendant Asta 2-frame 2-light	White	2* 5600lm/2* 5900lm	3000K/4000K	>80Ra	2* 40W	38°
2.06.0496/2.06.0497	Pendant Asta 2-frame 2-light	Black	2* 5600lm/2* 5900lm	3000K/4000K	>80Ra	2* 40W	38°
2.06.0499/2.06.0500	Pendant Asta 3-frame 2-light	Grey	2* 3700lm/2* 3850lm	3000K/4000K	>80Ra	2* 24W	38°
2.06.0505/2.06.0506	Pendant Asta 3-frame 2-light	White	2* 3700lm/2* 3850lm	3000K/4000K	>80Ra	2* 24W	38°
2.06.0511/2.06.0512	Pendant Asta 3-frame 2-light	Black	2* 3700lm/2* 3850lm	3000K/4000K	>80Ra	2* 24W	38°
2.06.0502/2.06.0503	Pendant Asta 3-frame 2-light	Grey	2* 5600lm/2* 5900lm	3000K/4000K	>80Ra	2* 40W	38°
2.06.0508/2.06.0509	Pendant Asta 3-frame 2-light	White	2* 5600lm/2* 5900lm	3000K/4000K	>80Ra	2* 40W	38°
2.06.0514/2.06.0515	Pendant Asta 3-frame 2-light	Black	2* 5600lm/2* 5900lm	3000K/4000K	>80Ra	2* 40W	38°
2.06.0517/2.06.0518	Pendant Asta 3-frame 3-light	Grey	3* 3700lm/3* 3850lm	3000K/4000K	>80Ra	3* 24W	38°
2.06.0523/2.06.0524	Pendant Asta 3-frame 3-light	White	3* 3700lm/3* 3850lm	3000K/4000K	>80Ra	3* 24W	38°
2.06.0529/2.06.0530	Pendant Asta 3-frame 3-light	Black	3* 3700lm/3* 3850lm	3000K/4000K	>80Ra	3* 24W	38°
2.06.0520/2.06.0521	Pendant Asta 3-frame 3-light	Grey	3* 5600lm/3* 5900lm	3000K/4000K	>80Ra	3* 40W	38°
2.06.0526/2.06.0527	Pendant Asta 3-frame 3-light	White	3* 5600lm/3* 5900lm	3000K/4000K	>80Ra	3* 40W	38°
2.06.0532/2.06.0533	Pendant Asta 3-frame 3-light	Black	3* 5600lm/3* 5900lm	3000K/4000K	>80Ra	3* 40W	38°

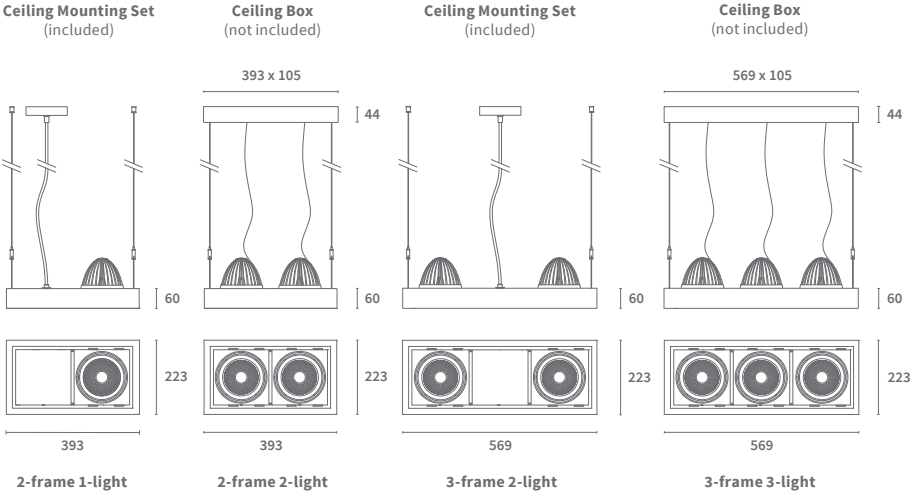

Also available: CRI >90Ra
This is a small selection from our portfolio.
Please contact us for a suitable solution for your lighting project.

AVAILABLE BEAM ANGLES	
Article No.	Description
5.14.0153	Reflector 18° for Asta Module
5.14.0154	Reflector 28° for Asta Module
5.14.0156	Reflector 60° for Asta Module

DRIVER BOX						
Article No.	Description	Color	Article No.	Description	Color	
2.01.0818	Ceiling Box for driver - 2-fold	Grey	2.01.0821	Ceiling Box for driver - 3-fold	Grey	
2.01.0819	Ceiling Box for driver - 2-fold	White	2.01.0822	Ceiling Box for driver - 3-fold	White	
2.01.0820	Ceiling Box for driver - 2-fold	Black	2.01.0823	Ceiling Box for driver - 3-fold	Black	

AVAILABLE DRIVERS	
Article No.	Description
-----	Dimmable driver



Ono LED

Pendant

Also available



LED Power	24W	42W
CRI	>90Ra	
CCT	3000K	3000K
LED Lumen	3100lm	5300lm
LED Efficacy	129lm/W	126lm/W
LOR	Up to 85%	
Driver	Non-Dimmable Driver (included)	

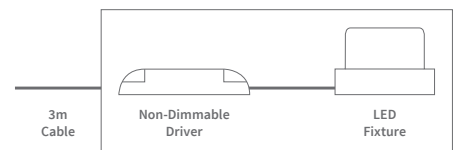

Ono LED 24W 3000K (Cover PC 406mm)

H [m]	[lux]	Beam [Ø cm]
1	2918	130
2	729	260
3	324	390
4	182	520
5	117	650

Beam (50%) Angle: 65°

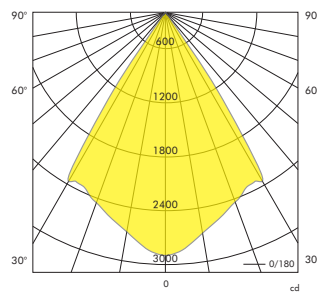

PRODUCT LIST

Article No.	Product Name	Color	LED Lumen	CCT	CRI	LED Power	Reflector (not included)
2.06.0454	Ono LED	Grey	3100lm	3000K	>90Ra	24W	80°
2.06.0455	Ono LED	Black	3100lm	3000K	>90Ra	24W	80°
2.06.0456	Ono LED	Grey	5300lm	3000K	>90Ra	42W	80°
2.06.0457	Ono LED	Black	5300lm	3000K	>90Ra	42W	80°

Also available: CRI >80Ra

This is a small selection from our portfolio. Please contact us for a suitable solution for your lighting project.

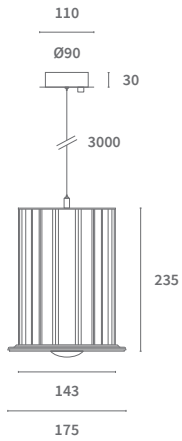

AVAILABLE COVERS

Article No.	Product Name	Finish	Material	Dimensions (Diameter, Height)
8.03.0623	Cover 315mm	Transparent	Polycarbonate	D: 315mm, H: 192mm
2.01.0956	Adaptor plate for Cover 315mm	Grey	Metal	
2.01.0957	Adaptor plate for Cover 315mm	Black	Metal	
8.03.0629	Cover 406mm	Transparent	Polycarbonate	D: 410mm, H: 277mm
5.14.0032	Cover 536mm	Transparent	Polycarbonate	D: 542mm, H: 320mm

AVAILABLE REFLECTORS

Article No.	Product Name	Finish	Material	Dimensions (Diameter, Height)
5.14.0197	Cover 38°	Anodised	Aluminium	D: 418mm, H: 280mm
5.14.0198	Cover 38°	Black	Aluminium	D: 418mm, H: 280mm



Surface



Galex II

Ceiling Mounted Adjustable 1-light

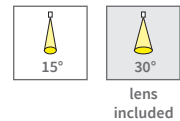

LED Power	7.6W		
CRI	>90Ra		
CCT	2700K	3000K	4000K
LED Lumen	544lm	560lm	611lm
LED Efficacy	71lm/W	73lm/W	80lm/W
LOR	>90%		
Driver	Dimmable 230V LED*		
Dimmable with	Leading / Trailing Edge Dimmer		

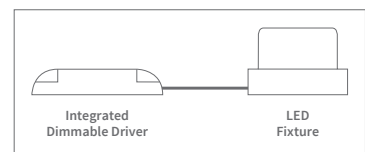

* Due to the 230V frequency of 50Hz, some people may experience discomfort caused by the strobe effect of the light.

Galex II 7.6W 3000K

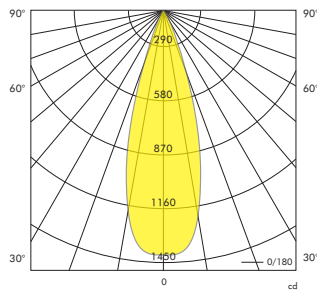
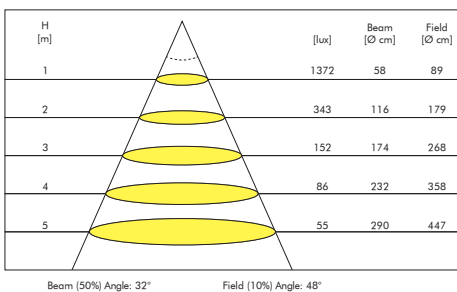

PRODUCT LIST

Article No.	Product Name	Color	LED Lumen	CCT	CRI	LED Power	Lens
2.17.2039	Galex II Adjustable 1-light	White	544lm	2700K	>90Ra	7.6W	30°
2.17.2042	Galex II Adjustable 1-light	Black	544lm	2700K	>90Ra	7.6W	30°
2.17.2040	Galex II Adjustable 1-light	White	560lm	3000K	>90Ra	7.6W	30°
2.17.2043	Galex II Adjustable 1-light	Black	560lm	3000K	>90Ra	7.6W	30°

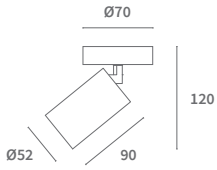

ALSO AVAILABLE

Article No.	Product Name	Color	LED Lumen	CCT	CRI	LED Power	Lens
2.01.1015	Lens 15° for Galex II Adjustable						
2.17.2036*	Galex II Adjustable 1-light	Grey	544lm	2700K	>90Ra	7.6W	30°
2.17.2037*	Galex II Adjustable 1-light	Grey	560lm	3000K	>90Ra	7.6W	30°
2.17.2038*	Galex II Adjustable 1-light	Grey	611lm	4000K	>90Ra	7.6W	30°
2.17.2041*	Galex II Adjustable 1-light	White	611lm	4000K	>90Ra	7.6W	30°
2.17.2044*	Galex II Adjustable 1-light	Black	611lm	4000K	>90Ra	7.6W	30°

* Minimum order quantity: 50 units



Galex II

Ceiling Mounted
Adjustable 2-light

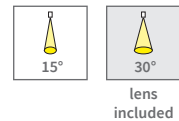

LED Power	2 x 7.6W		
CRI	>90Ra		
CCT	2700K	3000K	4000K
LED Lumen	2 x 544lm	2 x 560lm	2 x 611lm
LED Efficacy	71lm/W	73lm/W	80lm/W
LOR	>90%		
Driver	Dimmable 230V LED*		
Dimmable with	Leading / Trailing Edge Dimmer		

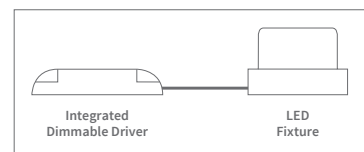

* Due to the 230V frequency of 50Hz, some people may experience discomfort caused by the strobe effect of the light.

Galex II 7.6W 3000K (per spot head)

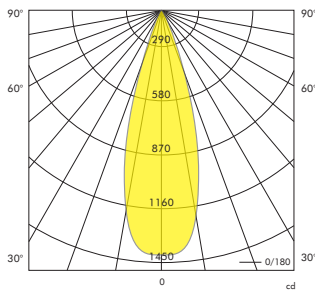
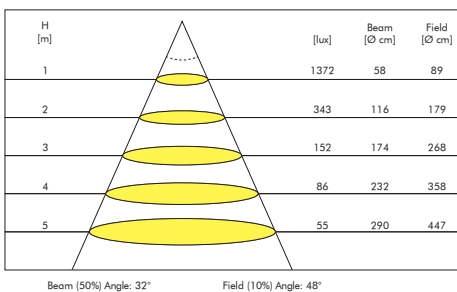

PRODUCT LIST

Article No.	Product Name	Color	LED Lumen	CCT	CRI	LED Power	Lens
2.17.2048	Galex II Adjustable 2-light	White	2 x 544lm	2700K	>90Ra	2 x 7.6W	30°
2.17.2051	Galex II Adjustable 2-light	Black	2 x 544lm	2700K	>90Ra	2 x 7.6W	30°
2.17.2049	Galex II Adjustable 2-light	White	2 x 560lm	3000K	>90Ra	2 x 7.6W	30°
2.17.2052	Galex II Adjustable 2-light	Black	2 x 560lm	3000K	>90Ra	2 x 7.6W	30°

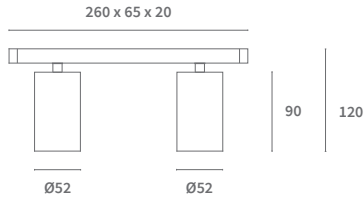

ALSO AVAILABLE

Article No.	Product Name	Color	LED Lumen	CCT	CRI	LED Power	Lens
2.01.1015	Lens 15° for Galex II Adjustable						
2.17.2045*	Galex II Adjustable 2-light	Grey	2 x 544lm	2700K	>90Ra	2 x 7.6W	30°
2.17.2046*	Galex II Adjustable 2-light	Grey	2 x 560lm	3000K	>90Ra	2 x 7.6W	30°
2.17.2047*	Galex II Adjustable 2-light	Grey	2 x 611lm	4000K	>90Ra	2 x 7.6W	30°
2.17.2050*	Galex II Adjustable 2-light	White	2 x 611lm	4000K	>90Ra	2 x 7.6W	30°
2.17.2053*	Galex II Adjustable 2-light	Black	2 x 611lm	4000K	>90Ra	2 x 7.6W	30°

* Minimum order quantity: 50 units



Vide

Ceiling Mounted
Fixed

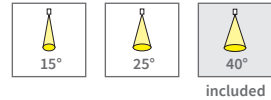

LED Power	20W		
CRI	>95Ra		>90Ra
CCT	2700K	3000K	4000K
LED Lumen	1300lm	1350lm	1400lm
LOR	>85%		
Driver	500mA Dimmable Driver (included)		

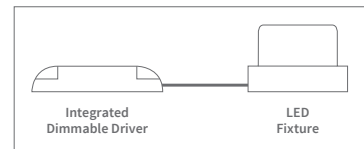

Vide 20W 3000K

H [m]	[lux]	Beam [Ø cm]	Field [Ø cm]
1	3335	65	117
2	834	129	235
3	371	194	352
4	208	258	469
5	133	323	587

Beam (50%) Angle: 36° Field (10%) Angle: 61°

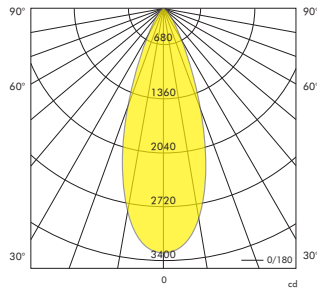

PRODUCT LIST

Article No.	Product Name	Housing Color	Ring Color	LED Lumen	CCT	CRI	LED Power	Reflector
2.17.0920	Vide Surface Mounted Fixed	Grey	Grey	1300lm	2700K	>95Ra	20W	40°
2.17.0965	Vide Surface Mounted Fixed	White	White	1300lm	2700K	>95Ra	20W	40°
2.17.1010	Vide Surface Mounted Fixed	Black	Black	1300lm	2700K	>95Ra	20W	40°
2.17.0923	Vide Surface Mounted Fixed	Grey	Grey	1350lm	3000K	>95Ra	20W	40°
2.17.0968	Vide Surface Mounted Fixed	White	White	1350lm	3000K	>95Ra	20W	40°
2.17.1013	Vide Surface Mounted Fixed	Black	Black	1350lm	3000K	>95Ra	20W	40°
2.17.0926	Vide Surface Mounted Fixed	Grey	Grey	1400lm	4000K	>90Ra	20W	40°
2.17.0971	Vide Surface Mounted Fixed	White	White	1400lm	4000K	>90Ra	20W	40°
2.17.1016	Vide Surface Mounted Fixed	Black	Black	1400lm	4000K	>90Ra	20W	40°

Also available: other color combinations
 This is a small selection from our portfolio. Please contact us for a suitable solution for your lighting project.

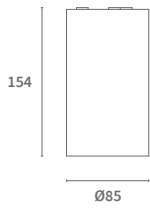

AVAILABLE BEAM ANGLES

Article No.	Description
5.14.0210	Reflector 15° for Vide
5.14.0211	Reflector 25° for Vide

ALSO AVAILABLE

Article No.	Description	Color
2.01.0927	Ring for Vide	Gold
2.01.0928	Ring for Vide	Grey
2.01.0929	Ring for Vide	White
2.01.0930	Ring for Vide	Black

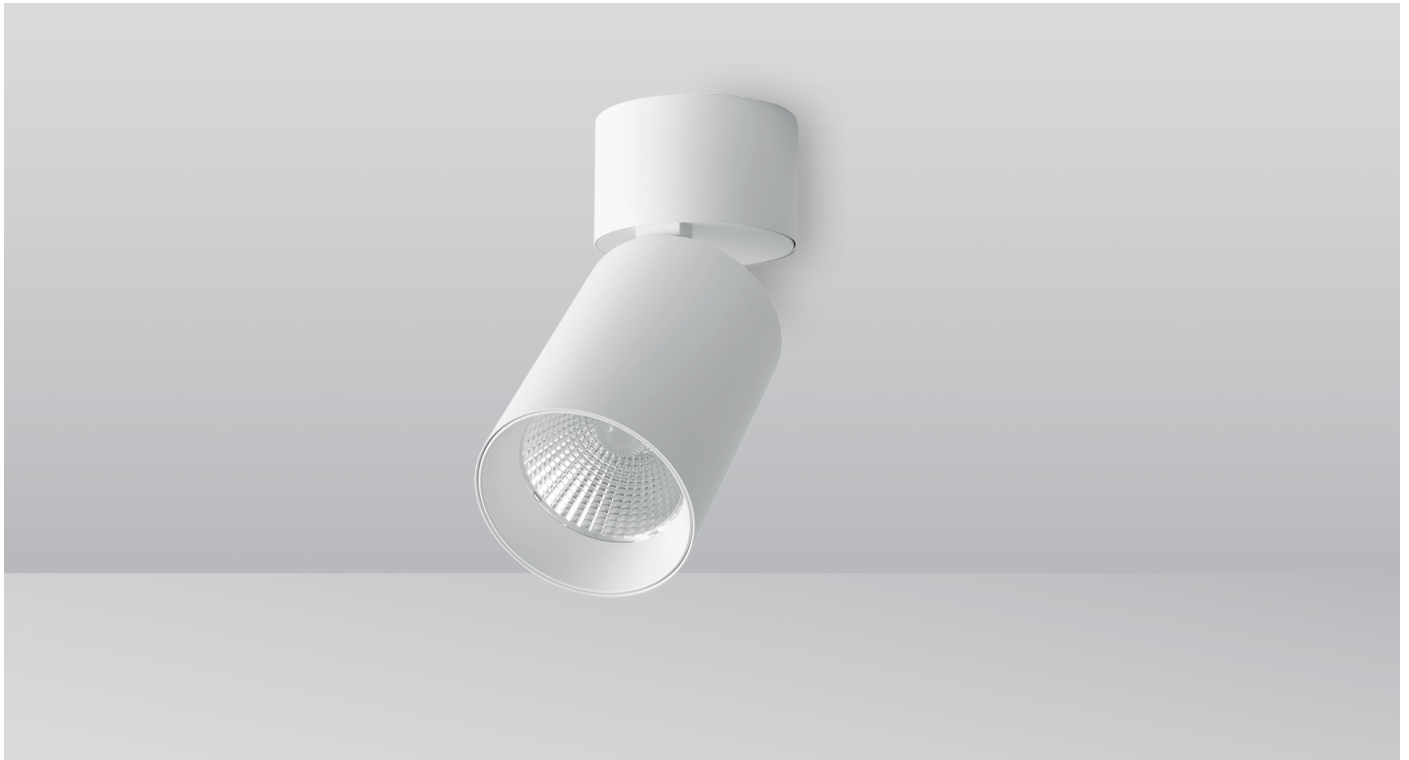

Vide

Ceiling Mounted
Adjustable



LED Power	20W		
CRI	>95Ra		>90Ra
CCT	2700K	3000K	4000K
LED Lumen	1300lm	1350lm	1400lm
LED Efficacy	65lm/W	67lm/W	70lm/W
LOR	>85%		
Driver	500mA Dimmable Driver (included)		

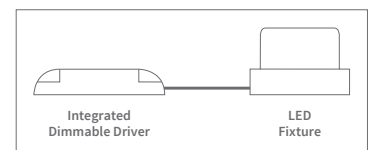

Vide 20W 3000K

H [m]	[lux]	Beam [Ø cm]	Field [Ø cm]
1	3335	65	117
2	834	129	235
3	371	194	352
4	208	258	469
5	133	323	587

Beam (50%) Angle: 36° Field (10%) Angle: 61°

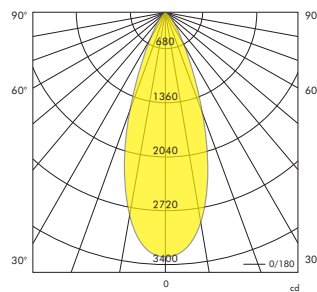

PRODUCT LIST

Article No.	Product Name	Housing Color	Ring Color	LED Lumen	CCT	CRI	LED Power	Reflector
2.17.1136	Vide Surface Mounted Adjustable	Grey	Grey	1300lm	2700K	>95Ra	20W	40°
2.17.1181	Vide Surface Mounted Adjustable	White	White	1300lm	2700K	>95Ra	20W	40°
2.17.1226	Vide Surface Mounted Adjustable	Black	Black	1300lm	2700K	>95Ra	20W	40°
2.17.1139	Vide Surface Mounted Adjustable	Grey	Grey	1350lm	3000K	>95Ra	20W	40°
2.17.1184	Vide Surface Mounted Adjustable	White	White	1350lm	3000K	>95Ra	20W	40°
2.17.1229	Vide Surface Mounted Adjustable	Black	Black	1350lm	3000K	>95Ra	20W	40°
2.17.1142	Vide Surface Mounted Adjustable	Grey	Grey	1400lm	4000K	>90Ra	20W	40°
2.17.1187	Vide Surface Mounted Adjustable	White	White	1400lm	4000K	>90Ra	20W	40°
2.17.1232	Vide Surface Mounted Adjustable	Black	Black	1400lm	4000K	>90Ra	20W	40°

Also available: other color combinations

This is a small selection from our portfolio. Please contact us for a suitable solution for your lighting project.

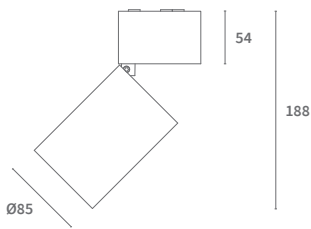

AVAILABLE BEAM ANGLES

Article No.	Description
5.14.0210	Reflector 15° for Vide
5.14.0211	Reflector 25° for Vide

ALSO AVAILABLE

Article No.	Description	Color
2.01.0927	Ring for Vide	Gold
2.01.0928	Ring for Vide	Grey
2.01.0929	Ring for Vide	White
2.01.0930	Ring for Vide	Black



Caja

Ceiling Mounted
Adjustable Square 1 & 2-light

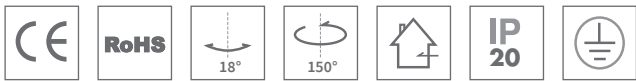

Model	1-light			2-light		
System Power	10W			20W		
CRI	>90Ra					
CCT	2700K	3000K	4000K	2700K	3000K	4000K
System Lumen	660lm	700lm	850lm	1320	1400	1700
System Efficacy	66lm/W	70lm/W	85lm/W	66lm/W	70lm/W	85lm/W
LOR	>85%					
Driver	250mA Dimmable Driver (included)					

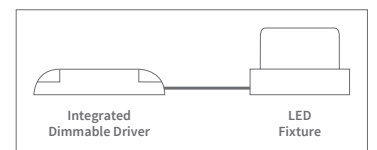

Caja 10W 3000K (per spot head)

H [m]	[lux]	Beam [Ø cm]
1	1269	70
2	317	140
3	141	210
4	79	280
5	51	350

Beam (50%) Angle: 38° Field (10%) Angle: 73°

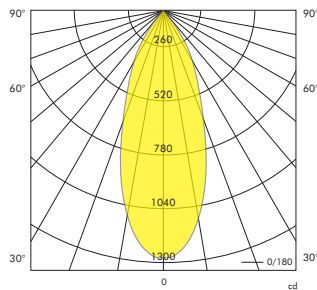

PRODUCT LIST

Article No.	Product Name	Color	System Lumen	CCT	CRI	System Power	Reflector
2.17.1578	Caja 1-light	White	660lm	2700K	>90Ra	10W	38°
2.17.1587	Caja 1-light	Black	660lm	2700K	>90Ra	10W	38°
2.17.1581	Caja 1-light	White	700lm	3000K	>90Ra	10W	38°
2.17.1590	Caja 1-light	Black	700lm	3000K	>90Ra	10W	38°
2.17.1584	Caja 1-light	White	850lm	4000K	>90Ra	10W	38°
2.17.1593	Caja 1-light	Black	850lm	4000K	>90Ra	10W	38°
2.17.1605	Caja 2-light	White	1320lm	2700K	>90Ra	20W	38°
2.17.1614	Caja 2-light	Black	1320lm	2700K	>90Ra	20W	38°
2.17.1608	Caja 2-light	White	1400lm	3000K	>90Ra	20W	38°
2.17.1617	Caja 2-light	Black	1400lm	3000K	>90Ra	20W	38°
2.17.1611	Caja 2-light	White	1700lm	4000K	>90Ra	20W	38°
2.17.1620	Caja 2-light	Black	1700lm	4000K	>90Ra	20W	38°

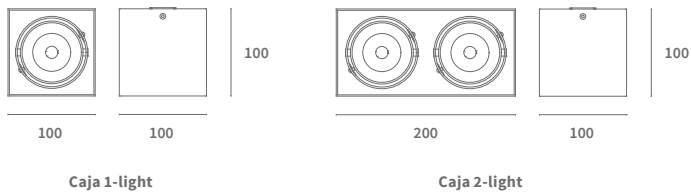

AVAILABLE BEAM ANGLES

Article No.	Description
5.14.0218	Reflector 25° for Caja
5.14.0220	Reflector 60° for Caja

ALSO AVAILABLE

Article No.	Description	Color
2.01.0976	Front Ring for Caja	White
2.01.0977	Front Ring for Caja	Black
2.01.0979	Cover Plate for Caja 1-light	White
2.01.0980	Cover Plate for Caja 1-light	Black
2.01.0982	Cover Plate for Caja 2-light	White
2.01.0983	Cover Plate for Caja 2-light	Black





Sarok

The Sarok is an architectural beauty within the range of Lumiparts.

This extensive and functional collection makes it, with its cube shape, a real eye-catcher. With the reflector in the Sarok, you get a beautiful and efficient lighting effect. The reflectors are available in the colors matt gold, matt silver, matt white and matt black. Together with its black or white housing, the Sarok can be adjusted to your liking and interior.

You can choose a single or double light source. Both are available in different color combinations. The Sarok is standard phase cut to be dimmable, to create the perfect light experience.



Sarok

Ceiling Mounted
1-light & 2-light



included

Model	1-light		2-light	
LED Power	15.5W		31W	
CRI	>90Ra			
CCT	2700K	3000K	2700K	3000K
LED Lumen	Up to 977lm	Up to 1001lm	Up to 1954lm	Up to 2002lm
LED Efficacy	Up to 63lm/W	Up to 64lm/W	Up to 63lm/W	Up to 64lm/W
Driver	Dimmable Driver (included)			

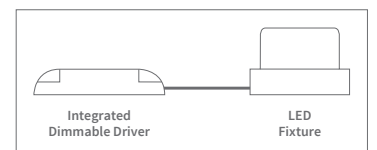

Sarok 15.5W 3000K

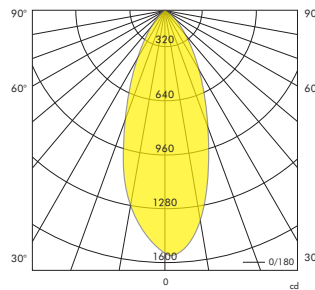
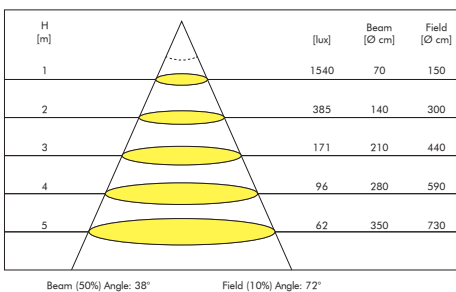

PRODUCT LIST

Article No.	Product Name	Housing Color	Cover Plate Color	Lumen	CCT	CRI	LED Power	Reflector
2.17.2439	Sarok 1-light	White	White	977lm	2700K	>90Ra	15.5W	36°
2.17.2440	Sarok 1-light	Black	Black	810lm	2700K	>90Ra	15.5W	36°
2.17.2441	Sarok 1-light	White	White	1001lm	3000K	>90Ra	15.5W	36°
2.17.2442	Sarok 1-light	Black	Black	899lm	3000K	>90Ra	15.5W	36°
2.17.2443	Sarok 2-light	White	White	1954lm	2700K	>90Ra	31W	2 x 36°
2.17.2444	Sarok 2-light	Black	Black	1620lm	2700K	>90Ra	31W	2 x 36°
2.17.2445	Sarok 2-light	White	White	2002lm	3000K	>90Ra	31W	2 x 36°
2.17.2446	Sarok 2-light	Black	Black	1798lm	3000K	>90Ra	31W	2 x 36°

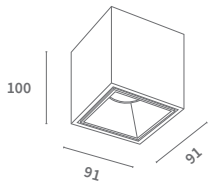

Sarok 1-light

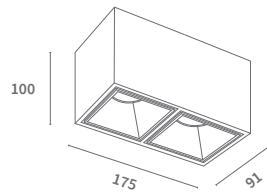

Sarok 2-light

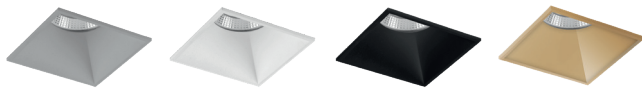

ALSO AVAILABLE

Article No.	Description	Color
2.01.1145	Cover Plate for Sarok	Grey
2.01.1146	Cover Plate for Sarok	White
2.01.1147	Cover Plate for Sarok	Black
2.01.1144	Cover Plate for Sarok	Gold

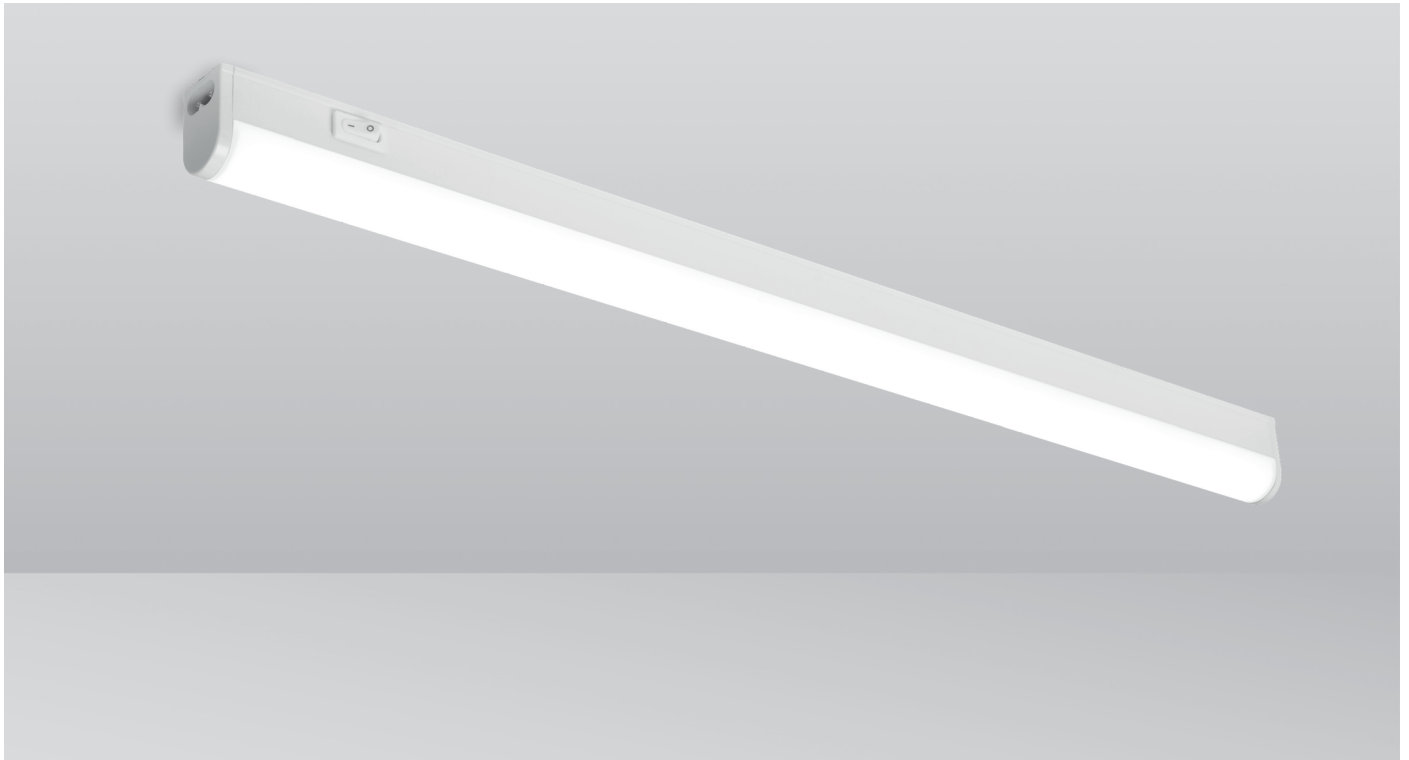

LupaStick

Surface Mounted
LED



Length	277mm	505mm	538mm	838mm	1138mm	1438mm
Power	4W	7W	9W	13W	18W	22W
CRI	>80Ra					
CCT	3000K	4000K	3000K	4000K	3000K	4000K
LED Lumen	270lm	300lm	495lm	550lm	650lm	720lm
Beam Angle	120°					
Max. Connectable Length	12 pieces					
Accessories	Coupling piece and coupling cable 20cm (included) Power cable white with plug 180cm (included) Mounting kit (included)					

LupaStick 22W 4000K

H [m]	Max [lux]	Med [lux]	Beam [Ø cm]
1	379	120	330
2	95	30	670
3	42	13	1000
4	34	11	1330
5	15	5	1670

Beam (50%) Angle: 118°

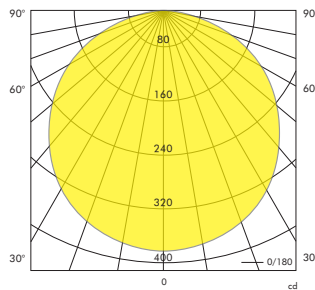

PRODUCT LIST

Article No.	Product Name	Length	Color	LED Lumen	CCT	CRI	Beam Angle
2.12.0289	LupaStick 4W	277mm	White	270lm	3000K	>80Ra	120°
2.12.0290	LupaStick 4W	277mm	White	300lm	4000K	>80Ra	120°
2.12.0291	LupaStick 7W	505mm	White	495lm	3000K	>80Ra	120°
2.12.0292	LupaStick 7W	505mm	White	550lm	4000K	>80Ra	120°
2.12.0293	LupaStick 9W	538mm	White	650lm	3000K	>80Ra	120°
2.12.0294	LupaStick 9W	538mm	White	720lm	4000K	>80Ra	120°
2.12.0295	LupaStick 13W	838mm	White	950lm	3000K	>80Ra	120°
2.12.0296	LupaStick 13W	838mm	White	1050lm	4000K	>80Ra	120°
2.12.0297	LupaStick 18W	1138mm	White	1390lm	3000K	>80Ra	120°
2.12.0298	LupaStick 18W	1138mm	White	1550lm	4000K	>80Ra	120°
2.12.0299	LupaStick 22W	1438mm	White	1620lm	3000K	>80Ra	120°
2.12.0300	LupaStick 22W	1438mm	White	1800lm	4000K	>80Ra	120°

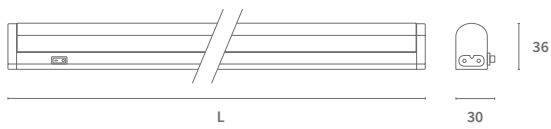

- 4W: L: 277mm
- 7W: L: 505mm
- 9W: L: 538mm
- 13W: L: 838mm
- 18W: L: 1138mm
- 22W: L: 1438mm

ALSO AVAILABLE

Article No.	Description	Color	Length
2.01.0535	Coupling Cable	White	50 cm
2.01.0536	Coupling Cable	White	100 cm



Kani

Wall Mounted
1-light & 2-light



Model	1-light		2-light	
System Power	5W		10W	
CRI	>80Ra			
CCT	2700K	3000K	2700K	3000K
System Lumen	127lm	138lm	254lm	276lm
System Efficacy	25lm/W	27lm/W	25lm/W	27lm/W
Input Voltage	230V AC			

Kani 5W 3000K (per spot head)

H [m]	[lux]	Beam [Ø cm]	Field [Ø cm]
1	62	220	570
2	16	440	1130
3	7	660	1700
4	4	880	2270
5	3	1100	2830

Beam (50%) Angle: 95°

Field (10%) Angle: 141°

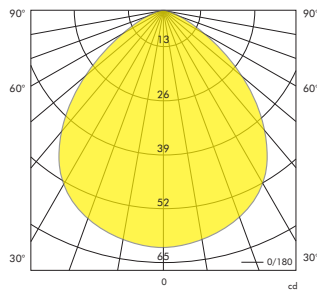

PRODUCT LIST

Article No.	Product Name	Color	System Lumen	CCT	CRI	System Power
2.19.0225	Kani 1-light	White	127lm	2700K	>80Ra	5W
2.19.0226	Kani 1-light	Black	127lm	2700K	>80Ra	5W
2.19.0227	Kani 1-light	White	138lm	3000K	>80Ra	5W
2.19.0228	Kani 1-light	Black	138lm	3000K	>80Ra	5W
2.19.0229	Kani 2-light	White	254lm	2700K	>80Ra	10W
2.19.0230	Kani 2-light	Black	254lm	2700K	>80Ra	10W
2.19.0231	Kani 2-light	White	276lm	3000K	>80Ra	10W
2.19.0233	Kani 2-light	Black	276lm	3000K	>80Ra	10W

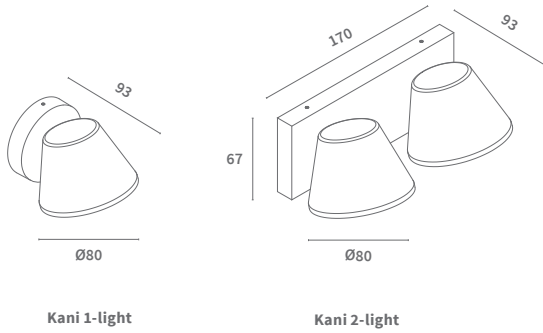

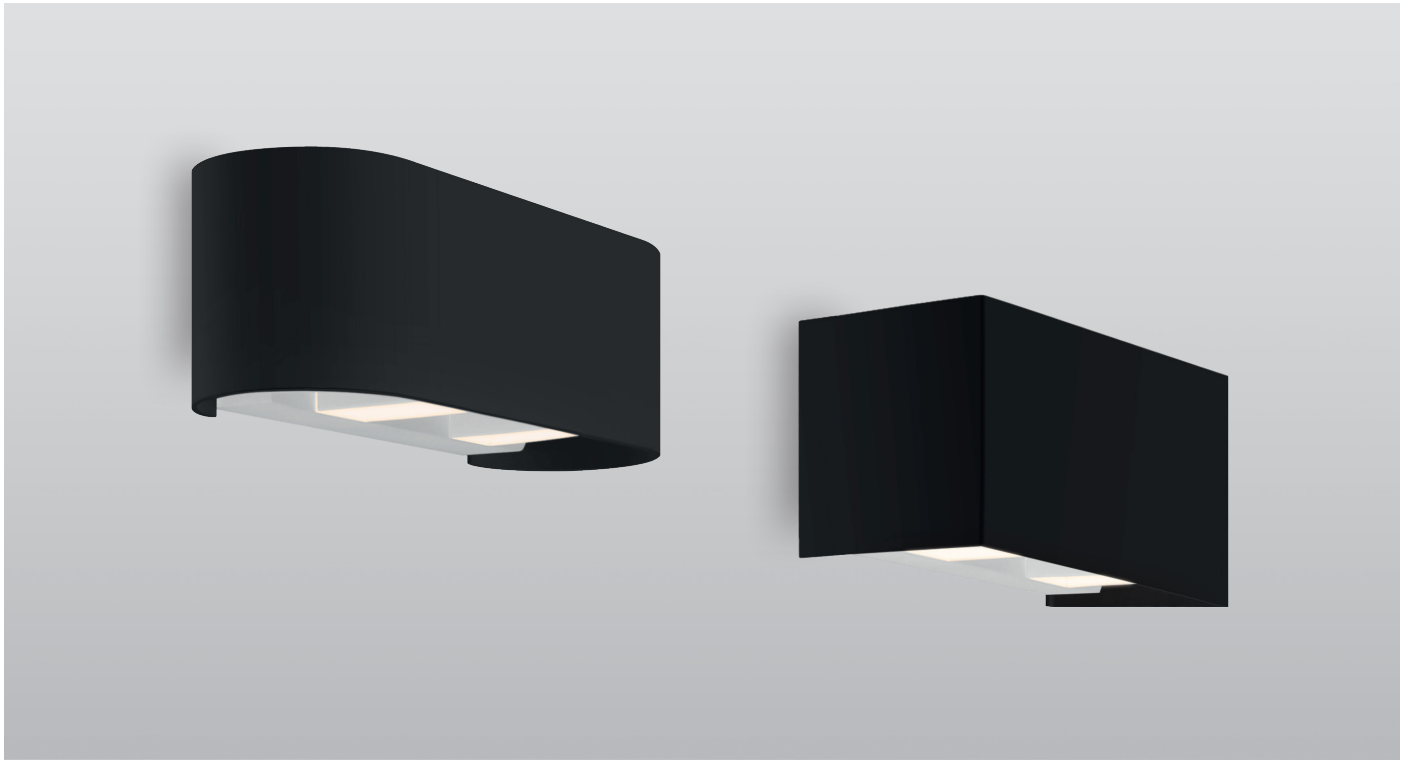

Latus

Wall Mounted
1-light & 2-light



Model	1-light		2-light	
System Power	7.4W		14.2W	
CRI	>80Ra			
CCT	2700K	3000K	2700K	3000K
System Lumen	451lm	484lm	900lm	964lm
System Efficacy	61lm/W	66lm/W	63lm/W	67lm/W
Driver	Non-Dimmable Driver (included)			

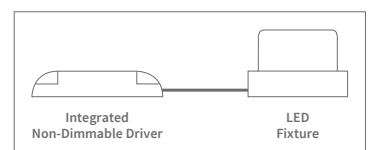

Latus 7.4W 3000K (adjustable beam angle)

H [m]	[lux]	Beam [Ø cm]
1	274	180
2	68	360
3	30	550
4	17	730
5	11	910

Beam (50%) Angle: 85° Field (10%) Angle: 111°

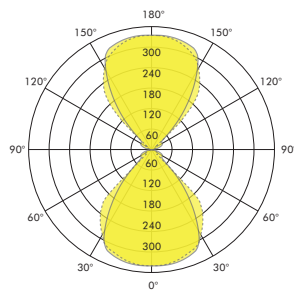

PRODUCT LIST

Article No.	Product Name	Shape	Color	System Lumen	CCT	CRI	System Power
2.19.0209	Latus 1-light	Round	White	451lm	2700K	>80Ra	7.4W
2.19.0210	Latus 1-light	Round	Black	451lm	2700K	>80Ra	7.4W
2.19.0211	Latus 1-light	Round	White	484lm	3000K	>80Ra	7.4W
2.19.0212	Latus 1-light	Round	Black	484lm	3000K	>80Ra	7.4W
2.19.0213	Latus 2-light	Round	White	900lm	2700K	>80Ra	14.2W
2.19.0214	Latus 2-light	Round	Black	900lm	2700K	>80Ra	14.2W
2.19.0215	Latus 2-light	Round	White	964lm	3000K	>80Ra	14.2W
2.19.0216	Latus 2-light	Round	Black	964lm	3000K	>80Ra	14.2W
2.19.0217	Latus 1-light	Square	White	451lm	2700K	>80Ra	7.4W
2.19.0218	Latus 1-light	Square	Black	451lm	2700K	>80Ra	7.4W
2.19.0219	Latus 1-light	Square	White	484lm	3000K	>80Ra	7.4W
2.19.0220	Latus 1-light	Square	Black	484lm	3000K	>80Ra	7.4W
2.19.0221	Latus 2-light	Square	White	900lm	2700K	>80Ra	14.2W
2.19.0222	Latus 2-light	Square	Black	900lm	2700K	>80Ra	14.2W
2.19.0223	Latus 2-light	Square	White	964lm	3000K	>80Ra	14.2W
2.19.0224	Latus 2-light	Square	Black	964lm	3000K	>80Ra	14.2W

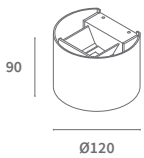

Latus 1-light
Round

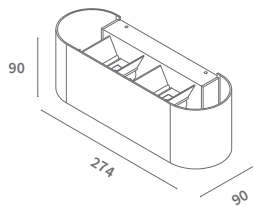

Latus 2-light
Round

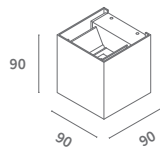

Latus 1-light
Square

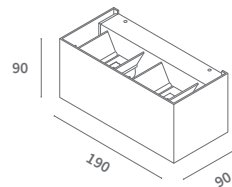

Latus 2-light
Square

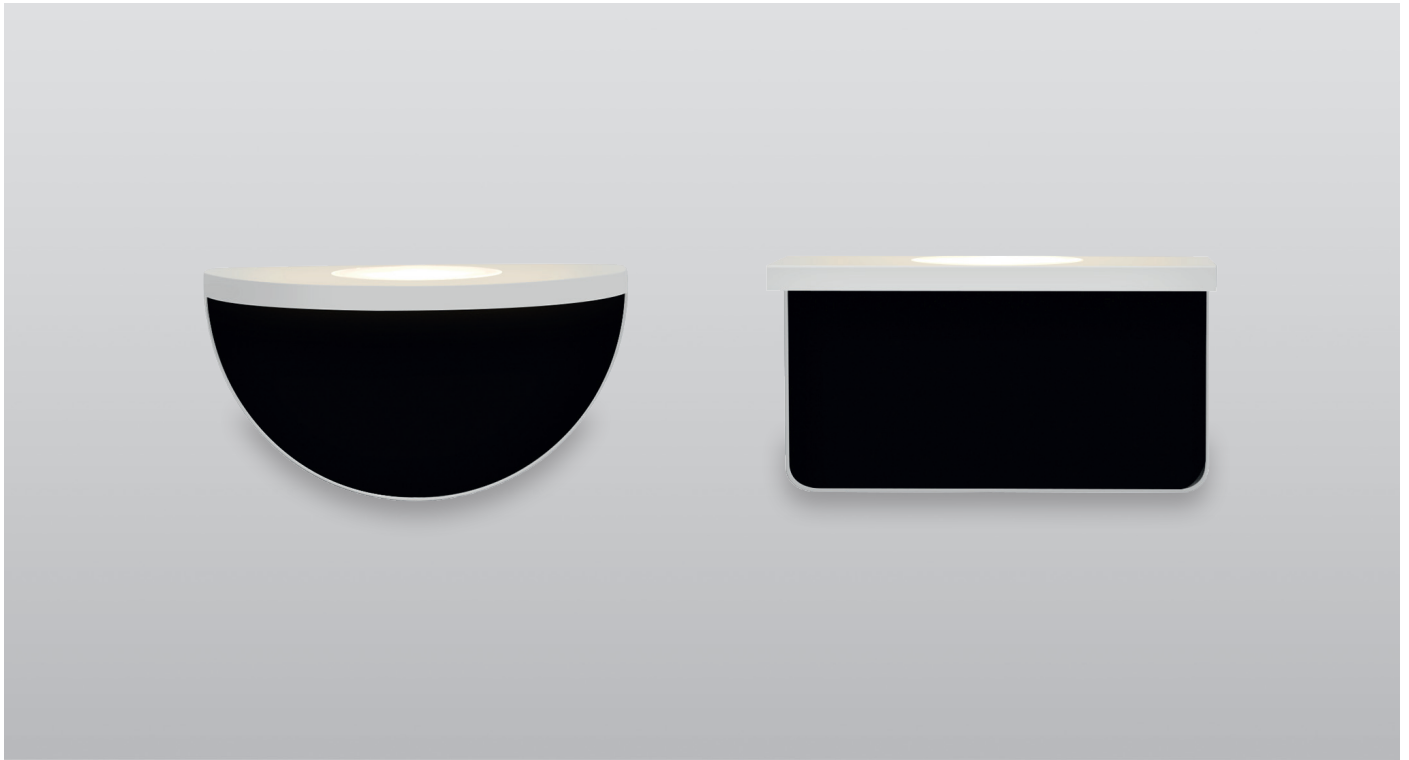

Cubit

Wall Mounted
Round & Square



System Power	3.9W
CRI	>80Ra
CCT	3000K
System Lumen	325lm
System Efficacy	83lm/W
Input Voltage	230V AC (TRIAC Dimmable)

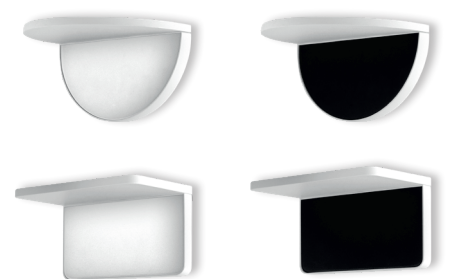

White and black faceplate included with each variant.

Cubit 3.9W 3000K

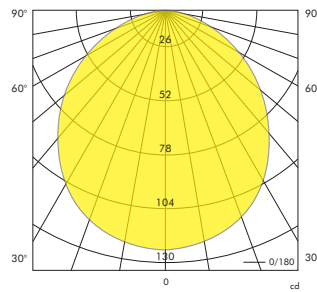
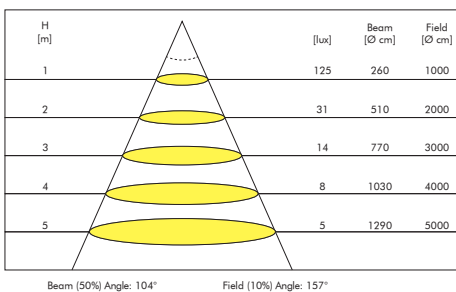

PRODUCT LIST

Article No.	Product Name	Color	System Lumen	CCT	CRI	System Power
2.19.0207	Cubit Round	White / Black	325lm	3000K	>80Ra	3.9W
2.19.0208	Cubit Square	White / Black	325lm	3000K	>80Ra	3.9W

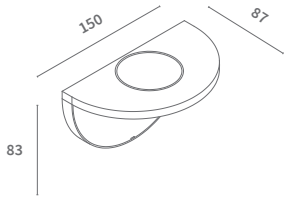

Cubit Round

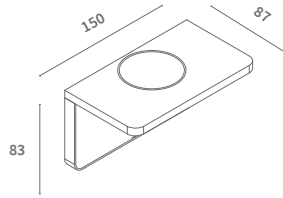

Cubit Square

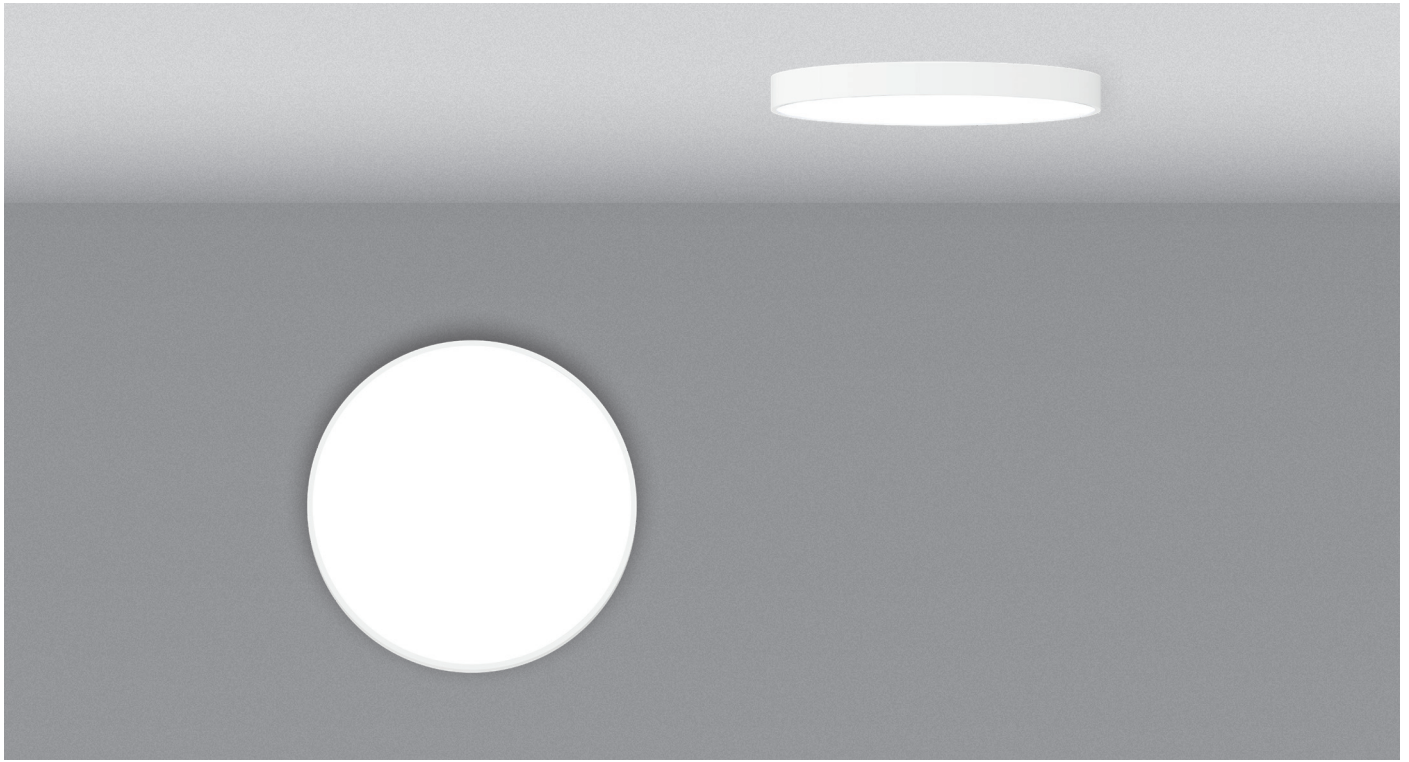

Ozola

Wall Mounted / Ceiling Mounted
LED

Switchable: 3000K / 3500K / 4000K
Adjustable light output: 100% / 75% / 50%



Size	480mm			600mm			900mm			1200mm		
System Power	40W			57W			92W			150W		
CRI	>80Ra											
CCT	3000K	3500K	4000K	3000K	3500K	4000K	3000K	3500K	4000K	3000K	3500K	4000K
System Lumen	3330lm	3480lm	3510lm	5220lm	5540lm	5575lm	7540lm	7850lm	7900lm	14450lm	14900lm	14630lm
System Efficacy	83lm/W	87lm/W	87lm/W	91lm/W	97lm/W	97lm/W	82lm/W	85lm/W	86lm/W	96lm/W	99lm/W	98lm/W
Driver	DALI Dimmable Driver (included)											

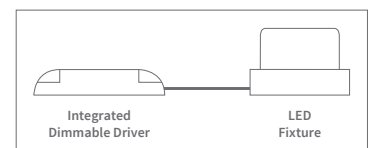
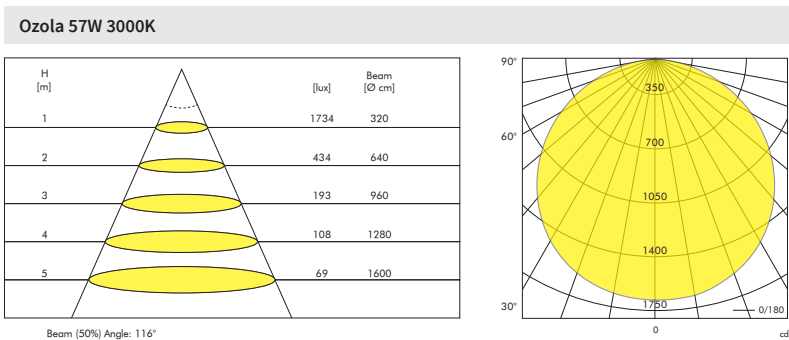

PRODUCT LIST

Article No.	Product Name	Size	Color	System Lumen	CCT	CRI	System Power
2.17.2633	Ozola	480mm	Grey	3330lm / 3480lm / 3510lm	3000K / 3500K / 4000K	>80Ra	40W
2.17.2634	Ozola	480mm	White	3330lm / 3480lm / 3510lm	3000K / 3500K / 4000K	>80Ra	40W
2.17.2635	Ozola	480mm	Black	3330lm / 3480lm / 3510lm	3000K / 3500K / 4000K	>80Ra	40W
2.17.2636	Ozola	600mm	Grey	5220lm / 5540lm / 5575lm	3000K / 3500K / 4000K	>80Ra	57W
2.17.2637	Ozola	600mm	White	5220lm / 5540lm / 5575lm	3000K / 3500K / 4000K	>80Ra	57W
2.17.2638	Ozola	600mm	Black	5220lm / 5540lm / 5575lm	3000K / 3500K / 4000K	>80Ra	57W
2.17.2639	Ozola	900mm	Grey	7540lm / 7850lm / 7900lm	3000K / 3500K / 4000K	>80Ra	92W
2.17.2640	Ozola	900mm	White	7540lm / 7850lm / 7900lm	3000K / 3500K / 4000K	>80Ra	92W
2.17.2641	Ozola	900mm	Black	7540lm / 7850lm / 7900lm	3000K / 3500K / 4000K	>80Ra	92W
2.17.2642	Ozola	1200mm	Grey	14450lm / 14900lm / 14630lm	3000K / 3500K / 4000K	>80Ra	150W
2.17.2643	Ozola	1200mm	White	14450lm / 14900lm / 14630lm	3000K / 3500K / 4000K	>80Ra	150W
2.17.2644	Ozola	1200mm	Black	14450lm / 14900lm / 14630lm	3000K / 3500K / 4000K	>80Ra	150W

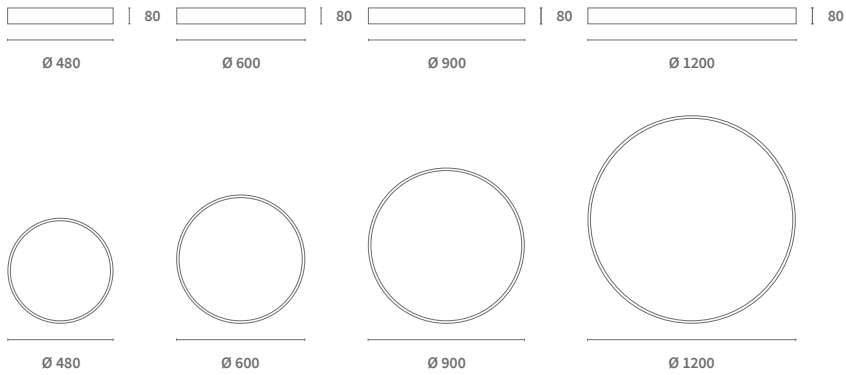

ALSO AVAILABLE

Article No. **Description**
See page 108 The Ozola is also available as a pendant variant.



LED Line Millo

Linear Lighting System



LED Strip	Extro 60LED 7,2W	Extro 60LED 14,4W	Extro 120LED 14,4W	Extro 120LED 28,8W	Extro 168LED 20,2W	LupaReel 60LED 4,8W	LupaReel 120LED 9,6W	LupaReel 36LED 8,6W	LupaReel 60LED 14,4W	LupaReel 84LED 17,1W	LupaReel 60+60LED 19,2W	LupaReel 84LED 17,1W
1m	√	√	√	√	√	√	√	√	√	√	√	√
2m	√	√	√	√	√	√	√	√	√	√	√	√
3m	√	√	√	√	√	√	√	√	√	√	√	√
4m	√	√	√	√	√	√	√	√	√	√	√	√
5m	√	√	√	√	√	√	√	√	√	√	√	√
6m	√	√	√	5+5m	5+5m	√	√	√	√	5+5m	5+5m	5+5m
7m	√	√	√	5+5m	5+5m	√	√	√	√	5+5m	5+5m	5+5m
8m	√	5+5m	5+5m	5+5m	5+5m	√	√	√	√	5+5m	5+5m	5+5m
9m	√	5+5m	5+5m	5+5m	5+5m	√	√	√	5+5m	5+5m	5+5m	5+5m
10m	√	5+5m	5+5m	5+5m	5+5m	√	√	√	5+5m	5+5m	5+5m	5+5m



2.19.0196
Punch tool for LED Line
(not included)

PRODUCT LIST

Article No.	Product Name	Color		Description
2.19.0194	LED Line Millo	White	○	Length: 10 meters
2.19.0195	LED Line Millo	Satin Silver	●	Length: 10 meters
2.19.0196	Punch Tool for LED Line Millo	Nickel Plated	●	Perforating tool for the LED Line.
2.19.0197	Spacer Bracket for LED Line Millo	White	○	A single LED Line can be mounted on the wall.
2.19.0198	Spacer Bracket for LED Line Millo	Satin Silver	●	A single LED Line can be mounted on the wall.
2.19.0199	Single Joint for LED Line Millo	White	○	A single LED Line can be mounted between two surfaces.
2.19.0200	Single Joint for LED Line Millo	Satin Silver	●	A single LED Line can be mounted between two surfaces.
2.19.0201	Triple Joint for LED Line Millo	White	○	Up to three separate LED Lines can be mounted between surfaces.
2.19.0202	Triple Joint for LED Line Millo	Satin Silver	●	Up to three separate LED Lines can be mounted between surfaces.
2.19.0203	Driver Box for LED Line Millo	White	○	Metal enclosure for the LED Strip driver.
2.19.0204	Driver Box for LED Line Millo	Satin Silver	●	Metal enclosure for the LED Strip driver.

LEDLINE

2.19.0194	LED Line	○
2.19.0195	LED Line	●

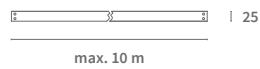

SPACER BRACKET

2.19.0197	Spacer Bracket	○
2.19.0198	Spacer Bracket	●

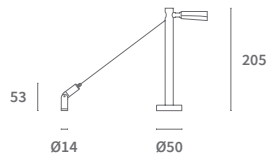

SINGLE JOINT

2.19.0199	Single Joint	○
2.19.0200	Single Joint	●

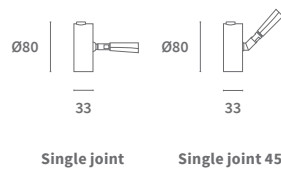

TRIPLE JOINT

2.19.0201	Triple Joint	○
2.19.0202	Triple Joint	●

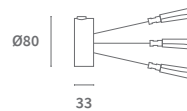

DRIVER BOX

2.19.0203	Driver Box	○
2.19.0204	Driver Box	●

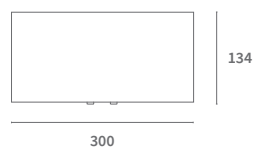



Track Systems



Sintra

3-Phase Track Light



System Power	7W			15W			27W		
CRI	>90Ra								
CCT	2700k	3000K	4000k	2700k	3000K	4000k	2700k	3000K	4000k
LED Lumen	674lm	722lm	775lm	1393lm	1440lm	1561lm	2786lm	2902lm	3121lm
LED Efficacy	112lm/W	120lm/W	129lm/W	116lm/W	120lm/W	130lm/W	116lm/W	120lm/W	120lm/W
LOR	>85%								
Driver	Dimmable Driver (included)			Dimmable Driver (included)			Dimmable Driver (included)		

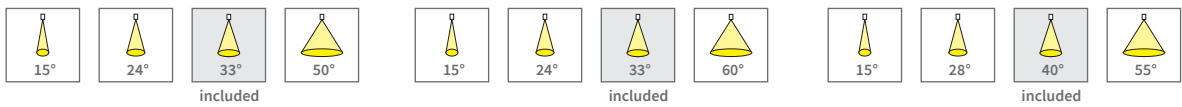

Sintra 27W 3000K

H [m]	[lux]	Beam [Ø cm]	Field [Ø cm]
1	6777	60	130
2	1694	120	260
3	753	180	380
4	424	230	510
5	271	290	640

Beam (50%) Angle: 33° Field (10%) Angle: 66°

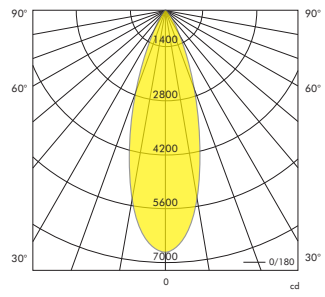

PRODUCT LIST

Article No.	Product Name	Color	LED Lumen	CCT	CRI	LED Power	Reflector
2.17.1844	Sintra 7W	Grey	674lm	2700K	>90Ra	6W	33°
2.17.1847	Sintra 7W	White	674lm	2700K	>90Ra	6W	33°
2.17.1850	Sintra 7W	Black	674lm	2700K	>90Ra	6W	33°
2.17.1845	Sintra 7W	Grey	722lm	3000K	>90Ra	6W	33°
2.17.1848	Sintra 7W	White	722lm	3000K	>90Ra	6W	33°
2.17.1851	Sintra 7W	Black	722lm	3000K	>90Ra	6W	33°
2.17.1846	Sintra 7W	Grey	775lm	4000K	>90Ra	6W	33°
2.17.1849	Sintra 7W	White	775lm	4000K	>90Ra	6W	33°
2.17.1852	Sintra 7W	Black	775lm	4000K	>90Ra	6W	33°
2.17.1853	Sintra 15W	Grey	1393lm	2700K	>90Ra	12W	33°
2.17.1857	Sintra 15W	White	1440lm	3000K	>90Ra	12W	33°
2.17.1859	Sintra 15W	Black	1393lm	2700K	>90Ra	12W	33°
2.17.1854	Sintra 15W	Grey	1440lm	3000K	>90Ra	12W	33°
2.17.1856	Sintra 15W	White	1393lm	2700K	>90Ra	12W	33°
2.17.1860	Sintra 15W	Black	1440lm	3000K	>90Ra	12W	33°
2.17.1855	Sintra 15W	Grey	1561lm	4000K	>90Ra	12W	33°
2.17.1858	Sintra 15W	White	1561lm	4000K	>90Ra	12W	33°
2.17.1861	Sintra 15W	Black	1561lm	4000K	>90Ra	12W	33°
2.17.1862	Sintra 27W	Grey	2786lm	2700K	>90Ra	24W	40°
2.17.1865	Sintra 27W	White	2786lm	2700K	>90Ra	24W	40°
2.17.1868	Sintra 27W	Black	2786lm	2700K	>90Ra	24W	40°
2.17.1863	Sintra 27W	Grey	2902lm	3000K	>90Ra	24W	40°
2.17.1866	Sintra 27W	White	2902lm	3000K	>90Ra	24W	40°
2.17.1869	Sintra 27W	Black	2902lm	3000K	>90Ra	24W	40°
2.17.1864	Sintra 27W	Grey	3121lm	4000K	>90Ra	24W	40°
2.17.1867	Sintra 27W	White	3121lm	4000K	>90Ra	24W	40°
2.17.1870	Sintra 27W	Black	3121lm	4000K	>90Ra	24W	40°

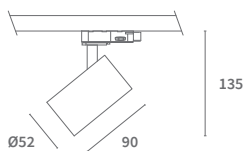

Sintra 7W

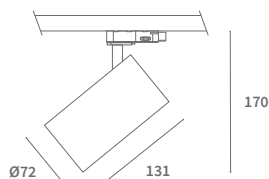

Sintra 15W

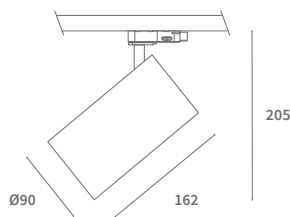

Sintra 27W

AVAILABLE BEAM ANGLES

Article No.	Description	Article No.	Description	Article No.	Description
5.14.0224	Reflector 15° for Sintra 7W	5.14.0228	Reflector 15° for Sintra 15W	5.14.0232	Reflector 15° for Sintra 27W
5.14.0225	Reflector 24° for Sintra 7W	5.14.0229	Reflector 24° for Sintra 15W	5.14.0233	Reflector 28° for Sintra 27W
5.14.0227	Reflector 50° for Sintra 7W	5.14.0231	Reflector 60° for Sintra 15W	5.14.0235	Reflector 55° for Sintra 27W

ALSO AVAILABLE

Article No.	Description	Article No.	Description	Article No.	Description
See page 186	3-Phase Tracks and accessories				
2.01.1012	Front Ring Black for Sintra 7W	2.01.1013	Front Ring Black for Sintra 15W	2.01.1014	Front Ring Black for Sintra 27W



Pinta In-track

The Pinta In-track is our newest addition to the Pinta series. We combine elegance with efficiency with its In-track adapter.

Powerful, passively cooled LED track spot, with integrated driver. The high luminous flux, its beautiful color rendering and compact design characterize the Pinta In-track as an all-rounder for your lighting projects.

In addition to Dali, the Pinta In-track is also available as a BlueDim version, so that you can operate each individual fixture with your smart device. This way the light experience can always be adjusted as desired.



ck





Pinta In-track

3-Phase Track Light

Also available



LED Power	from 11.5W up to 36.1W	from 11.5W up to 36.1W	from 11.2W up to 31.6W	from 11.5W up to 36.1W
CRI	>80Ra	>80Ra	>90Ra	>90Ra
CCT	3000K	3000K	3500K	4000K
LED Lumen	from 2054lm up to 5754lm	from 1702lm up to 4866lm	from 1701lm up to 4184lm	from 1836lm up to 5241lm
LED Efficacy	up to 179lm/W	up to 148lm/W	up to 153lm/W	up to 160lm/W
Driver	Non-Dimmable Driver (included)			

Pinta In-track 36.1W 3000K

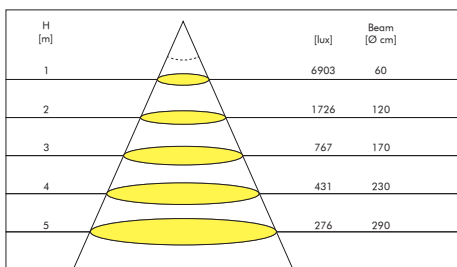

Beam (50%) Angle: 32°

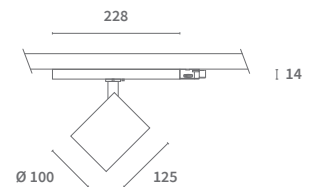
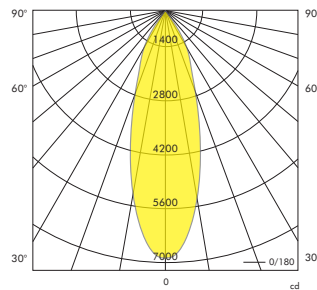

PRODUCT LIST

Pinta In-track model	Driver	LED Lumen	Reflector	CRI >80Ra / CCT 3000K			CRI >90Ra / CCT 3000K		
				Grey	White	Black	Grey	White	Black
Cost Efficient	350mA	1702lm	15°				2.17.3088	2.17.3092	2.17.3096
Cost Efficient	350mA	1702lm	24°				2.17.3089	2.17.3093	2.17.3097
Cost Efficient	350mA	1702lm	36°				2.17.3090	2.17.3094	2.17.3098
Cost Efficient	350mA	1702lm	60°				2.17.3091	2.17.3095	2.17.3099
Cost Efficient	350mA	2054lm	15°	2.17.3064	2.17.3068	2.17.3072			
Cost Efficient	350mA	2054lm	24°	2.17.3065	2.17.3069	2.17.3073			
Cost Efficient	350mA	2054lm	36°	2.17.3066	2.17.3070	2.17.3074			
Cost Efficient	350mA	2054lm	60°	2.17.3067	2.17.3071	2.17.3075			
Cost Efficient	500mA	2394lm	15°				2.17.3100	2.17.3104	2.17.3108
Cost Efficient	500mA	2394lm	24°				2.17.3101	2.17.3105	2.17.3109
Cost Efficient	500mA	2394lm	36°				2.17.3102	2.17.3106	2.17.3110
Cost Efficient	500mA	2394lm	60°				2.17.3103	2.17.3107	2.17.3111
Energy Efficient	500mA	2513lm	15°				2.17.3172	2.17.3176	2.17.3180
Energy Efficient	500mA	2513lm	24°				2.17.3173	2.17.3177	2.17.3181
Energy Efficient	500mA	2513lm	36°				2.17.3174	2.17.3178	2.17.3182
Energy Efficient	500mA	2513lm	60°				2.17.3175	2.17.3179	2.17.3183
Cost Efficient	500mA	2890lm	15°	2.17.3076	2.17.3080	2.17.3084			
Cost Efficient	500mA	2890lm	24°	2.17.3077	2.17.3081	2.17.3085			
Cost Efficient	500mA	2890lm	36°	2.17.3078	2.17.3082	2.17.3086			
Cost Efficient	500mA	2890lm	60°	2.17.3079	2.17.3083	2.17.3087			
Energy Efficient	500mA	2970lm	15°	2.17.3160	2.17.3164	2.17.3168			
Energy Efficient	500mA	2970lm	24°	2.17.3161	2.17.3165	2.17.3169			
Energy Efficient	500mA	2970lm	36°	2.17.3162	2.17.3166	2.17.3170			
Energy Efficient	500mA	2970lm	60°	2.17.3163	2.17.3167	2.17.3171			
Cost Efficient	700mA	3238lm	15°				2.17.2703	2.17.2707	2.17.2711
Cost Efficient	700mA	3238lm	24°				2.17.2704	2.17.2708	2.17.2712
Cost Efficient	700mA	3238lm	36°				2.17.2705	2.17.2709	2.17.2713
Cost Efficient	700mA	3238lm	60°				2.17.2706	2.17.2710	2.17.2714
Energy Efficient	700mA	3491lm	15°				2.17.2811	2.17.2815	2.17.2819
Energy Efficient	700mA	3491lm	24°				2.17.2812	2.17.2816	2.17.2820
Energy Efficient	700mA	3491lm	36°				2.17.2813	2.17.2817	2.17.2821
Energy Efficient	700mA	3491lm	60°				2.17.2814	2.17.2818	2.17.2822
Cost Efficient	700mA	3911lm	15°	2.17.2679	2.17.2683	2.17.2687			
Cost Efficient	700mA	3911lm	24°	2.17.2680	2.17.2684	2.17.2688			
Cost Efficient	700mA	3911lm	36°	2.17.2681	2.17.2685	2.17.2689			
Cost Efficient	700mA	3911lm	60°	2.17.2682	2.17.2686	2.17.2690			
Energy Efficient	700mA	4092lm	15°	2.17.2775	2.17.2779	2.17.2783			
Energy Efficient	700mA	4092lm	24°	2.17.2776	2.17.2780	2.17.2784			
Energy Efficient	700mA	4092lm	36°	2.17.2777	2.17.2781	2.17.2785			
Energy Efficient	700mA	4092lm	60°	2.17.2778	2.17.2782	2.17.2786			
Cost Efficient	900mA	3976lm	15°				2.17.2715	2.17.2719	2.17.2723
Cost Efficient	900mA	3976lm	24°				2.17.2716	2.17.2720	2.17.2724
Cost Efficient	900mA	3976lm	36°				2.17.2717	2.17.2721	2.17.2725
Cost Efficient	900mA	3976lm	60°				2.17.2718	2.17.2722	2.17.2726

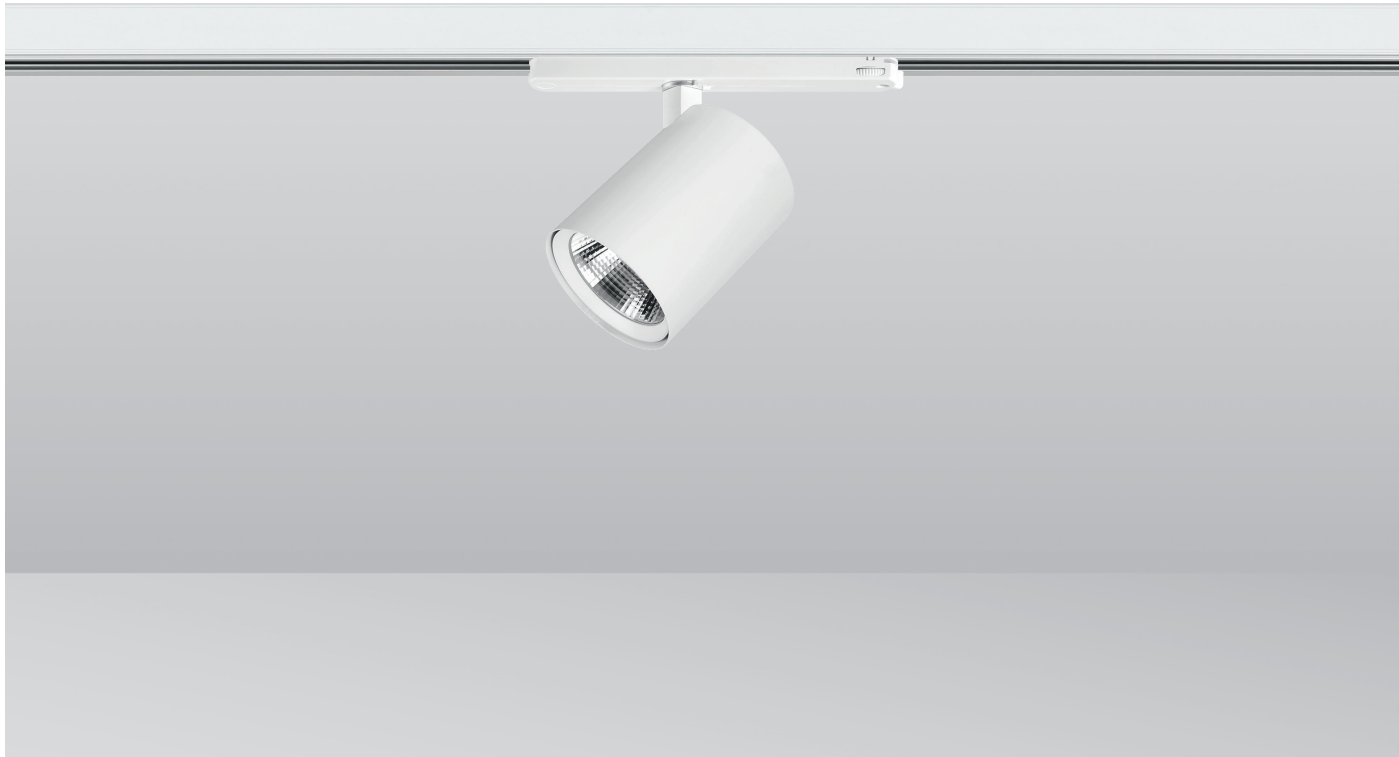

Pinta In-track

3-Phase Track Light

Also available



PRODUCT LIST									
Pinta In-track model	Driver	LED Lumen	Reflector	CRI >80Ra / CCT 3000K			CRI >90Ra / CCT 3000K		
				Grey	White	Black	Grey	White	Black
Cost Efficient	900mA	4803lm	15°	2.17.2691	2.17.2695	2.17.2699			
Cost Efficient	900mA	4803lm	24°	2.17.2692	2.17.2696	2.17.2700			
Cost Efficient	900mA	4803lm	36°	2.17.2693	2.17.2697	2.17.2701			
Cost Efficient	900mA	4803lm	60°	2.17.2694	2.17.2698	2.17.2702			
Energy Efficient	900mA	4305lm	15°				2.17.2823	2.17.2827	2.17.2831
Energy Efficient	900mA	4305lm	24°				2.17.2824	2.17.2828	2.17.2832
Energy Efficient	900mA	4305lm	36°				2.17.2825	2.17.2829	2.17.2833
Energy Efficient	900mA	4305lm	60°				2.17.2826	2.17.2830	2.17.2834
Energy Efficient	900mA	5091lm	15°	2.17.2787	2.17.2791	2.17.2795			
Energy Efficient	900mA	5091lm	24°	2.17.2788	2.17.2792	2.17.2796			
Energy Efficient	900mA	5091lm	36°	2.17.2789	2.17.2793	2.17.2797			
Energy Efficient	900mA	5091lm	60°	2.17.2790	2.17.2794	2.17.2798			
Energy Efficient	1050mA	4866lm	15°				2.17.2835	2.17.2839	2.17.2843
Energy Efficient	1050mA	4866lm	24°				2.17.2836	2.17.2840	2.17.2844
Energy Efficient	1050mA	4866lm	36°				2.17.2837	2.17.2841	2.17.2845
Energy Efficient	1050mA	4866lm	60°				2.17.2838	2.17.2842	2.17.2846

PRODUCT LIST

Pinta In-track model	Driver	LED Lumen	Reflector	CRI >80Ra / CCT 3000K			CRI >90Ra / CCT 3000K		
				Grey	White	Black	Grey	White	Black
Energy Efficient	1050mA	5754Lm	15°	2.17.2799	2.17.2803	2.17.2807			
Energy Efficient	1050mA	5754Lm	24°	2.17.2800	2.17.2804	2.17.2808			
Energy Efficient	1050mA	5754Lm	36°	2.17.2801	2.17.2805	2.17.2809			
Energy Efficient	1050mA	5754Lm	60°	2.17.2802	2.17.2806	2.17.2810			
Energy Efficient PW	500mA	2513lm	15°				2.17.3184	2.17.3188	2.17.3192
Energy Efficient PW	500mA	2513lm	24°				2.17.3185	2.17.3189	2.17.3193
Energy Efficient PW	500mA	2513lm	36°				2.17.3186	2.17.3190	2.17.3194
Energy Efficient PW	500mA	2513lm	60°				2.17.3187	2.17.3191	2.17.3195
Cost Efficient PW	700mA	3238Lm	15°				2.17.2727	2.17.2731	2.17.2735
Cost Efficient PW	700mA	3238Lm	24°				2.17.2728	2.17.2732	2.17.2736
Cost Efficient PW	700mA	3238Lm	36°				2.17.2729	2.17.2733	2.17.2737
Cost Efficient PW	700mA	3238Lm	60°				2.17.2730	2.17.2734	2.17.2738
Energy Efficient PW	700mA	3461Lm	15°				2.17.2847	2.17.2851	2.17.2855
Energy Efficient PW	700mA	3461Lm	24°				2.17.2848	2.17.2852	2.17.2856
Energy Efficient PW	700mA	3461Lm	36°				2.17.2849	2.17.2853	2.17.2857
Energy Efficient PW	700mA	3461Lm	60°				2.17.2850	2.17.2854	2.17.2858
Cost Efficient PW	900mA	3976Lm	15°				2.17.2739	2.17.2743	2.17.2747
Cost Efficient PW	900mA	3976Lm	24°				2.17.2740	2.17.2744	2.17.2748
Cost Efficient PW	900mA	3976Lm	36°				2.17.2741	2.17.2745	2.17.2749
Cost Efficient PW	900mA	3976Lm	60°				2.17.2742	2.17.2746	2.17.2750
Energy Efficient PW	900mA	4305Lm	15°				2.17.2859	2.17.2863	2.17.2867
Energy Efficient PW	900mA	4305Lm	24°				2.17.2860	2.17.2864	2.17.2868
Energy Efficient PW	900mA	4305Lm	36°				2.17.2861	2.17.2865	2.17.2869
Energy Efficient PW	900mA	4305Lm	60°				2.17.2862	2.17.2866	2.17.2870
Energy Efficient PW	1050mA	4866Lm	15°				2.17.2871	2.17.2875	2.17.2879
Energy Efficient PW	1050mA	4866Lm	24°				2.17.2872	2.17.2876	2.17.2880
Energy Efficient PW	1050mA	4866Lm	36°				2.17.2873	2.17.2877	2.17.2881
Energy Efficient PW	1050mA	4866Lm	60°				2.17.2874	2.17.2878	2.17.2882

PRODUCT LIST

Pinta In-track model	Driver	LED Lumen	Reflector	CRI >90Ra / CCT 3500K			CRI >90Ra / CCT 4000K		
				Grey	White	Black	Grey	White	Black
Cost Efficient PW	350mA	1836lm	15°				2.17.3124	2.17.3128	2.17.3132
Cost Efficient PW	350mA	1836lm	24°				2.17.3125	2.17.3129	2.17.3133
Cost Efficient PW	350mA	1836lm	36°				2.17.3126	2.17.3130	2.17.3134
Cost Efficient PW	350mA	1836lm	60°				2.17.3127	2.17.3131	2.17.3135
Cost Efficient PW	350mA	1701lm	15°	2.17.3112	2.17.3116	2.17.3120			
Cost Efficient PW	350mA	1701lm	24°	2.17.3113	2.17.3117	2.17.3121			
Cost Efficient PW	350mA	1701lm	36°	2.17.3114	2.17.3118	2.17.3122			
Cost Efficient PW	350mA	1701lm	60°	2.17.3115	2.17.3119	2.17.3123			
Cost Efficient PW	500mA	2583lm	15°				2.17.3148	2.17.3152	2.17.3156
Cost Efficient PW	500mA	2583lm	24°				2.17.3149	2.17.3153	2.17.3157
Cost Efficient PW	500mA	2583lm	36°				2.17.3150	2.17.3154	2.17.3158
Cost Efficient PW	500mA	2583lm	60°				2.17.3151	2.17.3155	2.17.3159



Pinta In-track

3-Phase Track Light

Also available

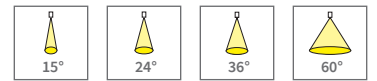

PRODUCT LIST

Pinta In-track model	Driver	LED Lumen	Reflector	CRI >90Ra / CCT 3500K			CRI >90Ra / CCT 4000K		
				Grey	White	Black	Grey	White	Black
Energy Efficient PW	500mA	2705lm	15°				2.17.3196	2.17.3200	2.17.3204
Energy Efficient PW	500mA	2705lm	24°				2.17.3197	2.17.3201	2.17.3205
Energy Efficient PW	500mA	2705lm	36°				2.17.3198	2.17.3202	2.17.3206
Energy Efficient PW	500mA	2705lm	60°				2.17.3199	2.17.3203	2.17.3207
Cost Efficient PW	500mA	2393lm	15°	2.17.3136	2.17.3140	2.17.3144			
Cost Efficient PW	500mA	2393lm	24°	2.17.3137	2.17.3141	2.17.3145			
Cost Efficient PW	500mA	2393lm	36°	2.17.3138	2.17.3142	2.17.3146			
Cost Efficient PW	500mA	2393lm	60°	2.17.3139	2.17.3143	2.17.3147			
Cost Efficient PW	700mA	3406Lm	15°	2.17.2920	2.17.2924	2.17.2928			
Cost Efficient PW	700mA	3406Lm	24°	2.17.2921	2.17.2925	2.17.2929			
Cost Efficient PW	700mA	3406Lm	36°	2.17.2922	2.17.2926	2.17.2930			
Cost Efficient PW	700mA	3406Lm	60°	2.17.2923	2.17.2927	2.17.2931			
Cost Efficient PW	700mA	3495Lm	15°				2.17.2751	2.17.2755	2.17.2759
Cost Efficient PW	700mA	3495Lm	24°				2.17.2752	2.17.2756	2.17.2760
Cost Efficient PW	700mA	3495Lm	36°				2.17.2753	2.17.2757	2.17.2761
Cost Efficient PW	700mA	3495Lm	60°				2.17.2754	2.17.2758	2.17.2762

PRODUCT LIST

Pinta In-track model	Driver	LED Lumen	Reflector	CRI >90Ra / CCT 3500K			CRI >90Ra / CCT 4000K		
				Grey	White	Black	Grey	White	Black
Energy Efficient PW	700mA	3727Lm	15°				2.17.2883	2.17.2887	2.17.2891
Energy Efficient PW	700mA	3727Lm	24°				2.17.2884	2.17.2888	2.17.2892
Energy Efficient PW	700mA	3727Lm	36°				2.17.2885	2.17.2889	2.17.2893
Energy Efficient PW	700mA	3727Lm	60°				2.17.2886	2.17.2890	2.17.2894
Cost Efficient PW	900mA	4184Lm	15°	2.17.2932	2.17.2936	2.17.2940			
Cost Efficient PW	900mA	4184Lm	24°	2.17.2933	2.17.2937	2.17.2941			
Cost Efficient PW	900mA	4184Lm	36°	2.17.2934	2.17.2938	2.17.2942			
Cost Efficient PW	900mA	4184Lm	60°	2.17.2935	2.17.2939	2.17.2943			
Cost Efficient PW	900mA	4293Lm	15°				2.17.2763	2.17.2767	2.17.2772
Cost Efficient PW	900mA	4293Lm	24°				2.17.2764	2.17.2768	2.17.2773
Cost Efficient PW	900mA	4293Lm	36°				2.17.2765	2.17.2769	2.17.2774
Cost Efficient PW	900mA	4293Lm	60°				2.17.2766	2.17.2770	
Energy Efficient PW	900mA	4637Lm	15°				2.17.2895	2.17.2899	2.17.2903
Energy Efficient PW	900mA	4637Lm	24°				2.17.2896	2.17.2900	2.17.2904
Energy Efficient PW	900mA	4637Lm	36°				2.17.2897	2.17.2901	2.17.2905
Energy Efficient PW	900mA	4637Lm	60°				2.17.2898	2.17.2902	2.17.2906
Energy Efficient PW	1050mA	5241Lm	15°				2.17.2907	2.17.2911	2.17.2915
Energy Efficient PW	1050mA	5241Lm	24°				2.17.2908	2.17.2912	2.17.2916
Energy Efficient PW	1050mA	5241Lm	36°				2.17.2909	2.17.2913	2.17.2917
Energy Efficient PW	1050mA	5241Lm	60°				2.17.2910	2.17.2914	2.17.2918

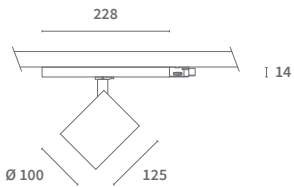

AVAILABLE BEAM ANGLES

Article No.	Description
5.14.0193	Reflector 15° for Pinta In-track
5.14.0194	Reflector 24° for Pinta In-track
5.14.0195	Reflector 36° for Pinta In-track
5.14.0196	Reflector 60° for Pinta In-track

ALSO AVAILABLE

Article No.	Description
See page 186	3-Phase Tracks and accessories



Pinta

3-Phase Track Light

Also available

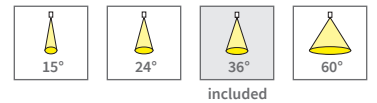

LED Power	17W	24W
CRI	>90Ra	
CCT	3000K	
LED Lumen	2200lm	3100lm
LED Efficacy	129lm/W	129lm/W
LOR	Up to 85%	
Driver	Non-Dimmable Driver (included)	

Pinta 24W 3000K

H [m]	[lux]	Beam [Ø cm]	Field [Ø cm]
1	6272	70	140
2	1568	130	280
3	697	200	410
4	392	260	550
5	251	330	690

Beam (50%) Angle: 36° Field (10%) Angle: 69°

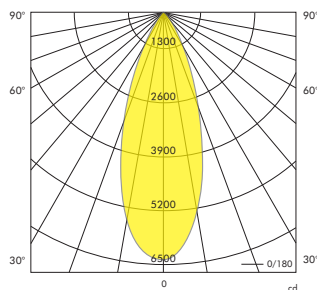

PRODUCT LIST

Article No.	Product Name	Color	LED Lumen	CCT	CRI	LED Power	Reflector
2.17.2558	Pinta	Grey	2200lm	3000K	>90Ra	17W	36°
2.17.1558	Pinta	White	2200lm	3000K	>90Ra	17W	36°
2.17.1278	Pinta	Black	2200lm	3000K	>90Ra	17W	36°
2.17.1352	Pinta	Grey	3100lm	3000K	>90Ra	24W	36°
2.17.1353	Pinta	White	3100lm	3000K	>90Ra	24W	36°
2.17.1307	Pinta	Black	3100lm	3000K	>90Ra	24W	36°

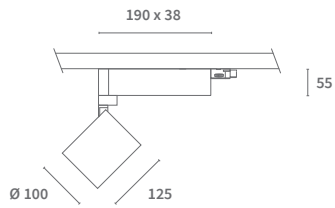
**AVAILABLE BEAM ANGLES**

Article No.	Description
5.14.0193	Reflector 15° for Pinta
5.14.0194	Reflector 24° for Pinta
5.14.0196	Reflector 60° for Pinta

ALSO AVAILABLE

Article No.	Description
See page 186	3-Phase Tracks and accessories



Tubo Maxi

3-Phase Track Light

Also available

- STONE
finish
- HIGH CRI
>90Ra
- FASHION
modules
- FOOD
modules
- CUSTOM
specs

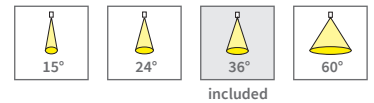

LED Power	24W	42W
CRI	>90Ra	
CCT	3000K	
LED Lumen	3100lm	4950lm
LED Efficacy	129lm/W	117lm/W
LOR	>85%	
Driver	Non-Dimmable Driver (included)	

Tubo Maxi 24W 3000K

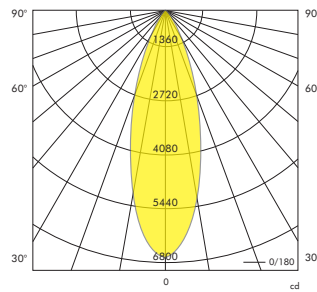
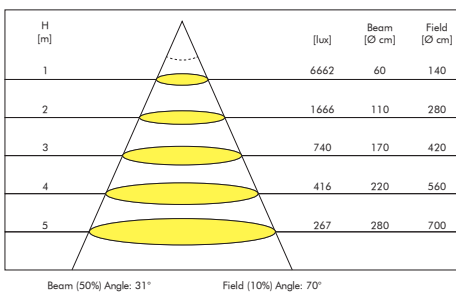

PRODUCT LIST

Article No.	Product Name	Color	LED Lumen	CCT	CRI	LED Power	Reflector
2.17.1814	Tubo Maxi	Grey	3100lm	3000K	>90Ra	24W	36°
2.17.1796	Tubo Maxi	White	3100lm	3000K	>90Ra	24W	36°
2.17.1898	Tubo Maxi	Black	3100lm	3000K	>90Ra	24W	36°
2.17.2559	Tubo Maxi	Grey	4950lm	3000K	>90Ra	42W	36°
2.17.0644	Tubo Maxi	White	4950lm	3000K	>90Ra	42W	36°
2.17.0645	Tubo Maxi	Black	4950lm	3000K	>90Ra	42W	36°

Also available: CRI >80Ra
 This is a small selection from our portfolio. Please contact us for a suitable solution for your lighting project.

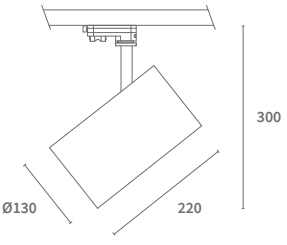

AVAILABLE BEAM ANGLES

Article No.	Description
5.14.0177	Reflector 15° for Tubo Maxi
5.14.0178	Reflector 24° for Tubo Maxi
5.14.0180	Reflector 60° for Tubo Maxi

ALSO AVAILABLE

Article No.	Description	Article No.	Description	Article No.	Description
See page 186	3-Phase Tracks and accessories	2.01.0805	Honeycomb Louvre for Tubo Maxi	2.01.0809	Barn Doors Grey for Tubo Maxi
-----	DALI Dimmable Driver	2.01.0806	Snoot Grey / Black for Tubo Maxi	2.01.0810	Barn Doors White for Tubo Maxi
		2.01.0807	Snoot White / Black for Tubo Maxi	2.01.0811	Barn Doors Black for Tubo Maxi
		2.01.0808	Snoot Black / Black for Tubo Maxi	2.01.0945	Front Ring Black for Tubo Maxi



Tubo Short

3-Phase Track Light

Also available

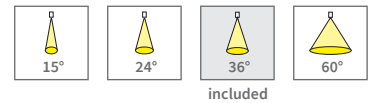

LED Power	24W	31W
CRI	>90Ra	
CCT	3000K	
LED Lumen	3100lm	3800lm
LED Efficacy	129lm/W	122lm/W
LOR	>85%	
Driver	Non-Dimmable Driver (included)	

Tubo Short 24W 3000K

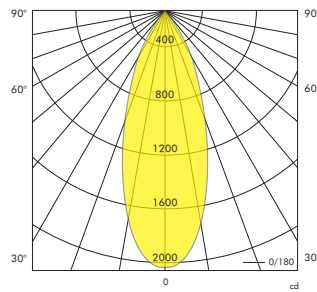
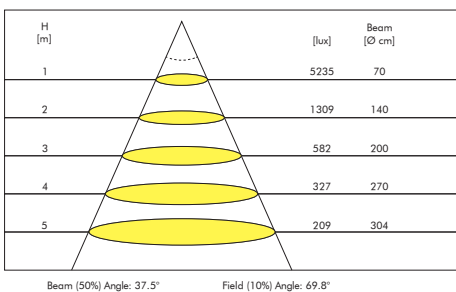

PRODUCT LIST

Article No.	Product Name	Color	LED Lumen	CCT	CRI	LED Power	Reflector
2.17.2515	Tubo Short	Grey	3100lm	3000K	>90Ra	24W	36°
2.17.2516	Tubo Short	White	3100lm	3000K	>90Ra	24W	36°
2.17.2517	Tubo Short	Black	3100lm	3000K	>90Ra	24W	36°
2.17.2675	Tubo Short	Grey	3800lm	3000K	>90Ra	31W	36°
2.17.2529	Tubo Short	White	3800lm	3000K	>90Ra	31W	36°
2.17.2554	Tubo Short	Black	3800lm	3000K	>90Ra	31W	36°

Also available: CRI >80Ra

This is a small selection from our portfolio. Please contact us for a suitable solution for your lighting project.

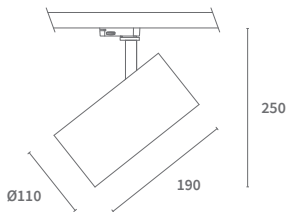

AVAILABLE BEAM ANGLES

Article No.	Description
5.14.0173	Reflector 15° for Tubo Short
5.14.0174	Reflector 24° for Tubo Short
5.14.0176	Reflector 60° for Tubo Short

ALSO AVAILABLE

Article No.	Description	Article No.	Description	Article No.	Description
See page 186	3-Phase Tracks and accessories	2.01.0933	Honeycomb Louvre for Tubo Short	2.01.0971	Snoot Black / Black for Tubo Short
-----	DALI Dimmable Driver	2.01.0942	Front Ring Black for Tubo Short	2.01.0951	Barn Doors Grey for Tubo Short
		2.01.0969	Snoot Grey / Black for Tubo Short	2.01.0952	Barn Doors White for Tubo Short
		2.01.0970	Snoot White / Black for Tubo Short	2.01.0953	Barn Doors Black for Tubo Short



Vide

3-Phase Track Light



LED Power	20W		
CRI	>95Ra		>90Ra
CCT	2700K	3000K	4000K
LED Lumen	1300lm	1350lm	1400lm
LED Efficacy	65lm/W	67lm/W	70lm/W
LOR	>85%		
Driver	Dimmable Driver (included)		

Vide 20W 3000K

H [m]	[lux]	Beam [Ø cm]	Field [Ø cm]
1	3335	65	117
2	834	129	235
3	371	194	352
4	208	258	469
5	133	323	587

Beam (50%) Angle: 36° Field (10%) Angle: 61°

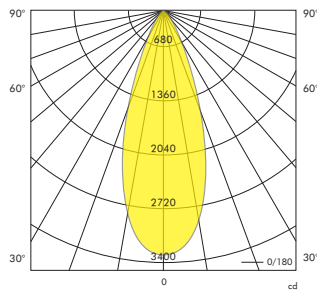

PRODUCT LIST

Article No.	Product Name	Housing Color	Ring Color	LED Lumen	CCT	CRI	LED Power	Reflector
2.17.1633	Vide Track	Grey	Grey	1300lm	2700K	>95Ra	20W	40°
2.17.1636	Vide Track	Grey	Grey	1350lm	3000K	>95Ra	20W	40°
2.17.1639	Vide Track	Grey	Grey	1400lm	4000K	>90Ra	20W	40°
2.17.1678	Vide Track	White	White	1300lm	2700K	>95Ra	20W	40°
2.17.1681	Vide Track	White	White	1350lm	3000K	>95Ra	20W	40°
2.17.1684	Vide Track	White	White	1400lm	4000K	>90Ra	20W	40°
2.17.1723	Vide Track	Black	Black	1300lm	2700K	>95Ra	20W	40°
2.17.1726	Vide Track	Black	Black	1350lm	3000K	>95Ra	20W	40°
2.17.1729	Vide Track	Black	Black	1400lm	4000K	>90Ra	20W	40°

Also available: other color combinations
 This is a small selection from our portfolio. Please contact us for a suitable solution for your lighting project.

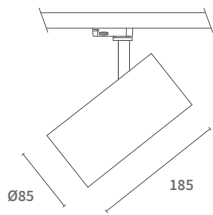

AVAILABLE BEAM ANGLES

Article No.	Description
5.14.0210	Reflector 15° for Vide Track
5.14.0211	Reflector 25° for Vide Track

ALSO AVAILABLE

Article No.	Description	Color
See page 186	3-Phase Tracks and accessories	
2.01.0927	Ring for Vide Track	Gold
2.01.0928	Ring for Vide Track	Grey
2.01.0929	Ring for Vide Track	White
2.01.0930	Ring for Vide Track	Black



Galex II

3-Phase Track Light

3-light



lens included

LED Power	3 x 7.6W
CRI	>90Ra
CCT	3000K
LED Lumen	2519lm
LED Efficacy	70lm/W
Driver	Non-Dimmable Driver (included)

Galex II 3000K (per spot head)

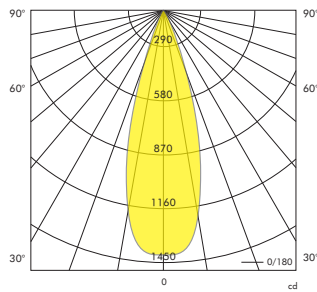
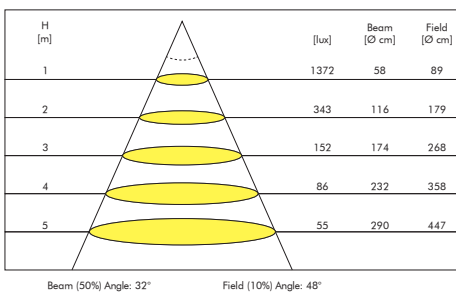

PRODUCT LIST

Article No.	Product Name	Color	LED Lumen	CCT	CRI	LED Power	Lens
2.17.2447	Galex II 3-light	White	2519lm	3000K	>90Ra	3 x 7.6W	8°
2.17.2448	Galex II 3-light	Black	2519lm	3000K	>90Ra	3 x 7.6W	8°

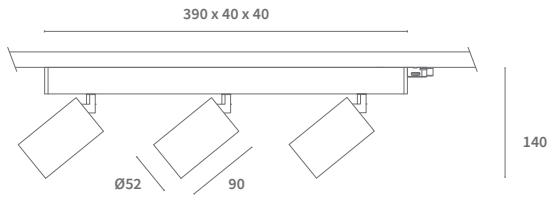
**ALSO AVAILABLE**

Article No.	Description
See page 186	3-Phase Tracks and accessories



Froxen

3-Phase Track Light

Also available

- STONE
finish
- HIGH CRI
>90Ra
- FASHION
modules
- FOOD
modules
- CUSTOM
specs

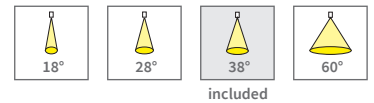

LED Power	24W	42W
CRI	>90Ra	
CCT	3000K	
LED Lumen	3100lm	5300lm
LED Efficacy	129lm/W	126lm/W
LOR	Up to 85%	
Driver	Non-Dimmable Driver (included)	

Froxen 42W 3000K

H [m]	[lux]	Beam [Ø cm]	Field [Ø cm]
1	7528	70	130
2	1883	140	270
3	837	220	400
4	470	290	540
5	302	360	670

Beam (50%) Angle: 40° Field (10%) Angle: 68°

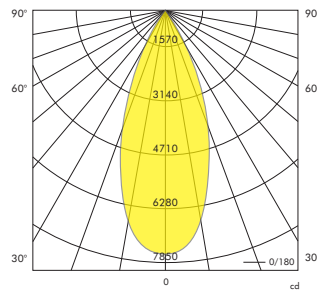

PRODUCT LIST

Article No.	Product Name	Color	LED Lumen	CCT	CRI	LED Power	Reflector
2.11.1494	Froxen	Grey	3100lm	3000K	>90Ra	24W	38°
2.11.0570	Froxen	White	3100lm	3000K	>90Ra	24W	38°
2.11.0464	Froxen	Black	3100lm	3000K	>90Ra	24W	38°
2.11.0421	Froxen	Grey	5300lm	3000K	>90Ra	42W	38°
2.11.0422	Froxen	White	5300lm	3000K	>90Ra	42W	38°
2.11.0423	Froxen	Black	5300lm	3000K	>90Ra	42W	38°

Also available: CRI >80Ra

This is a small selection from our portfolio. Please contact us for a suitable solution for your lighting project.

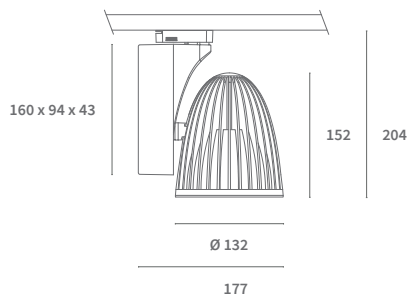

AVAILABLE BEAM ANGLES

Article No.	Description
5.14.0153	Reflector 18° for Froxen
5.14.0154	Reflector 28° for Froxen
5.14.0156	Reflector 60° for Froxen

ALSO AVAILABLE

Article No.	Description
See page 186	3-Phase Tracks and accessories
-----	DALI Dimmable Driver



Floresta

3-Phase Track Light



lens included

LED Power	24.5W
CRI	>90Ra
CCT	2700K
LED Lumen	2550lm
LED Efficacy	104lm/W
LOR	67%
Driver	Non-Dimmable or Dimmable Driver (included)

Floresta 24.5W 3000K

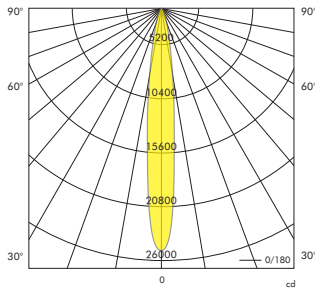
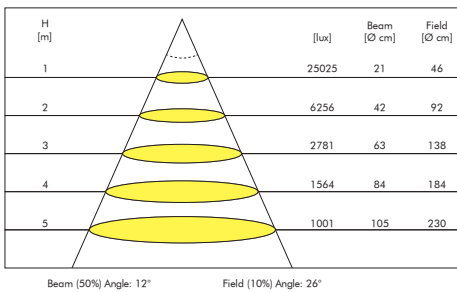

PRODUCT LIST

Article No.	Product Name	Color	LED Lumen	CCT	CRI	LED Power	Reflector
2.17.0634	Floresta	Black	2550lm	2700K	>90Ra	24.5W	8°
2.17.0656	Floresta - Dimmable	Black	2550lm	2700K	>90Ra	24.5W	8°

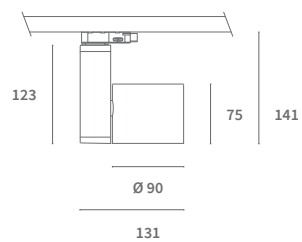
**ALSO AVAILABLE**

Article No.	Description
See page 186	3-Phase Tracks and accessories

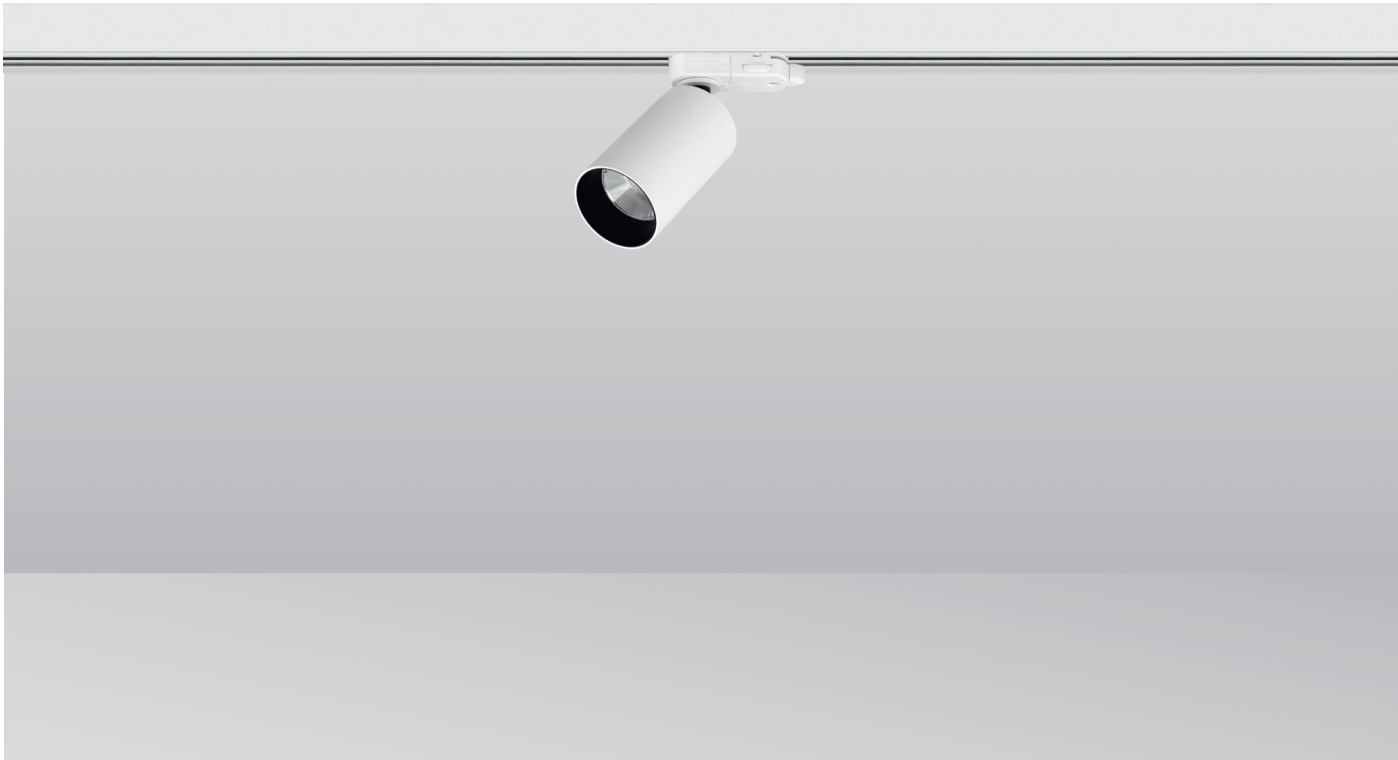

Galex II

3-Phase Track Light

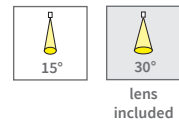

LED Power	7.6W (230V)*		
CRI	>90Ra		
CCT	2700K	3000K	4000K
LED Lumen	544lm	560lm	611lm
LED Efficacy	up to 80lm/W		
LOR	>90%		
Driver	Dimmable Driver (included)		

* Due to the 230V frequency of 50Hz, some people may experience discomfort caused by the strobe effect of the light.

Galex II 7.6W 3000K

H [m]	[lux]	Beam [Ø cm]	Field [Ø cm]
1	1372	58	89
2	343	116	179
3	152	174	268
4	86	232	358
5	55	290	447

Beam (50%) Angle: 32° Field (10%) Angle: 48°

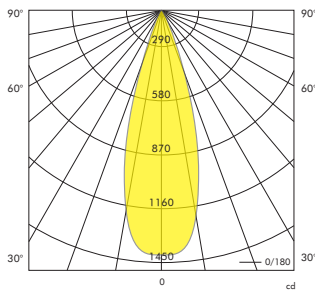

PRODUCT LIST

Article No.	Product Name	Color	Lumen	CCT	CRI	LED Power	Reflector
2.17.2054	Galex II	Grey	544lm	2700K	>90Ra	7.6W	30°
2.17.2055	Galex II	Grey	560lm	3000K	>90Ra	7.6W	30°
2.17.2056	Galex II	Grey	611lm	4000K	>90Ra	7.6W	30°
2.17.2057	Galex II	White	544lm	2700K	>90Ra	7.6W	30°
2.17.2058	Galex II	White	560lm	3000K	>90Ra	7.6W	30°
2.17.2059	Galex II	White	611lm	4000K	>90Ra	7.6W	30°
2.17.2060	Galex II	Black	544lm	2700K	>90Ra	7.6W	30°
2.17.2061	Galex II	Black	560lm	3000K	>90Ra	7.6W	30°
2.17.2062	Galex II	Black	611lm	4000K	>90Ra	7.6W	30°

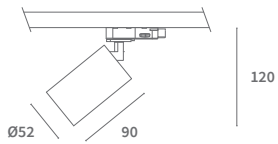

ALSO AVAILABLE

Article No.	Description
See page 186	3-Phase Tracks and accessories
2.01.1015	Lens 15° for Galex II



Wally Track

3-Phase Track Light

Wallwasher

Also available

- HIGH CRI
>90Ra
- FASHION
modules
- FOOD
modules
- CUSTOM
specs

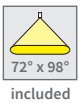

LED Power	24W	42W
CRI	>90Ra	
CCT	3000K	3000K PW
LED Lumen	3100lm	5300lm
LED Efficacy	129lm/W	126lm/W
LOR	Up to 85%	
Driver	Non-Dimmable Driver (included)	

Wally Track 24W 3000K

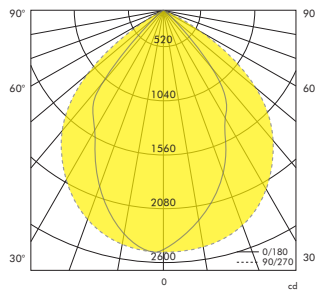
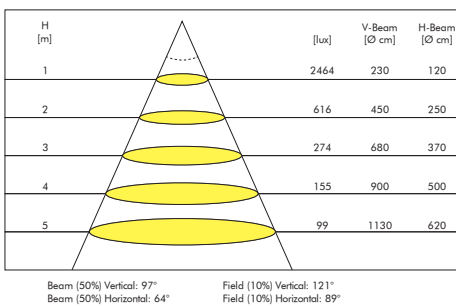

PRODUCT LIST

Article No.	Product Name	Color	LED Lumen	CCT	CRI	LED Power	Reflector
2.17.1259	Wally Track	Grey	3700lm	3000K	>90Ra	24W	72° x 98°
2.17.1495	Wally Track	White	3700lm	3000K	>90Ra	24W	72° x 98°
2.17.1276	Wally Track	Black	3700lm	3000K	>90Ra	24W	72° x 98°
2.17.2359	Wally Track	Grey	3850lm	3000K PW	>90Ra	42W	72° x 98°
2.17.2270	Wally Track	White	3850lm	3000K PW	>90Ra	42W	72° x 98°
2.17.2244	Wally Track	Black	3850lm	3000K PW	>90Ra	42W	72° x 98°

Also available: CRI >80Ra

This is a small selection from our portfolio. Please contact us for a suitable solution for your lighting project.

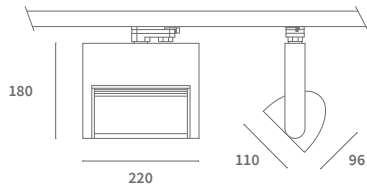

ALSO AVAILABLE

Article No.	Description
See page 186	3-Phase Tracks and accessories
-----	DALI Dimmable Driver



Forte

3-Phase Track Light

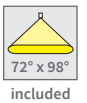

LED Power	94.2W	
CRI	>80Ra	
CCT	3000K	4000K
LED Lumen	12360lm	12680lm
LED Efficacy	131lm/W	134lm/W
LOR	Up to 85%	
Driver	1750mA Non-Dimmable Driver (included)	

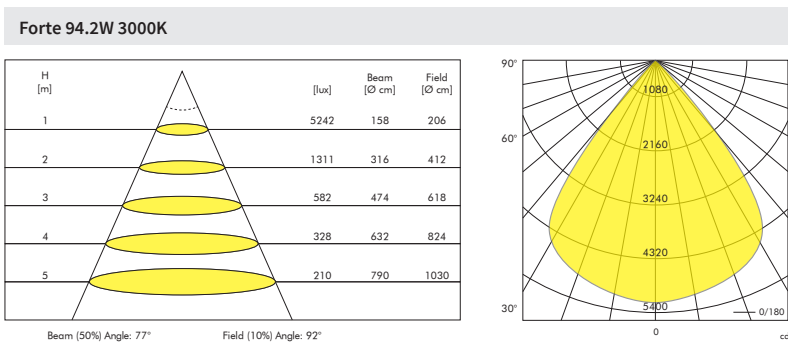

PRODUCT LIST

Article No.	Product Name	Color	LED Lumen	CCT	CRI	LED Power	Reflector
2.17.2221	Forte	Grey	12360lm	3000K	>80Ra	94.2W	72° x 98°
2.17.2222	Forte	White	12680lm	4000K	>80Ra	94.2W	72° x 98°
2.17.2223	Forte	Grey	12360lm	3000K	>80Ra	94.2W	72° x 98°
2.17.2224	Forte	White	12680lm	4000K	>80Ra	94.2W	72° x 98°

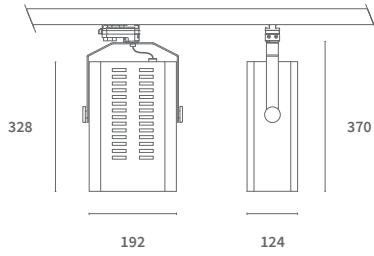

Barndoors
(not included)

ALSO AVAILABLE

Article No.	Description
See page 186	3-Phase Track and accessories
2.01.1043	Barndoors Black for Forte

ALSO AVAILABLE

Article No.	Description
-----	DALI Dimmable Driver

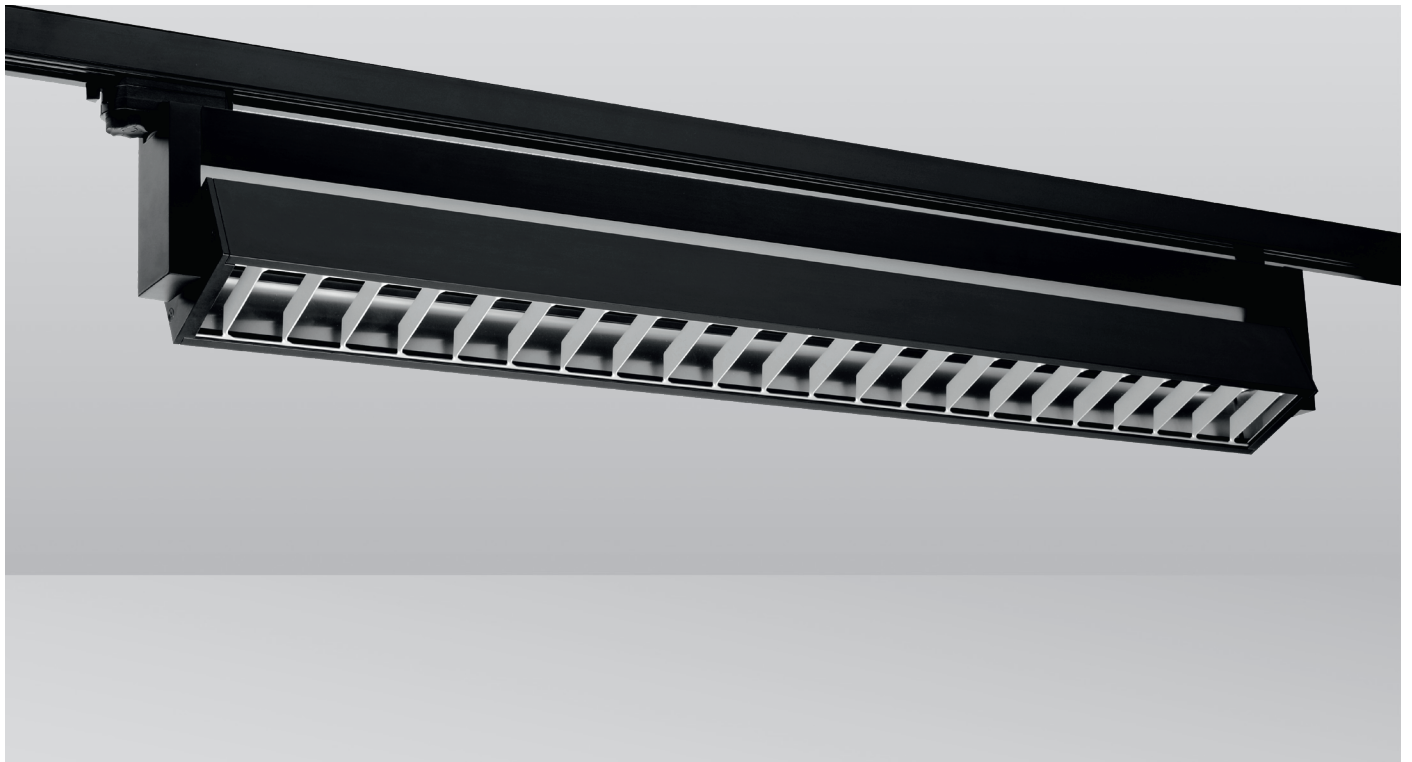

Raillux Mono

3-Phase Track Light

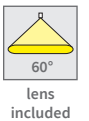

UGR	UGR <19	
System Power	40W	
CRI	>80Ra	
CCT	3000K	4000K
System Lumen	3800lm	3910lm
System Efficacy	95lm/W	96lm/W
LOR	Up to 80%	
Driver	Non-Dimmable Driver (included)	

Raillux Mono 40W 3000K

H [m]	[lux]	Beam [Ø cm]
1	2481	160
2	620	320
3	276	480
4	155	630
5	99	790

Beam (50%) Angle: 77°

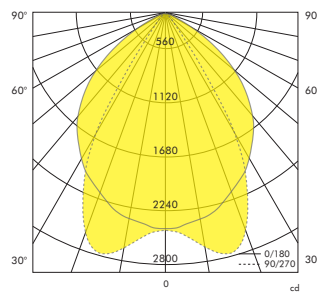

PRODUCT LIST

Article No.	Product Name	Housing Color	Louvre Color	System Lumen	CCT	CRI	System Power	Lens
2.16.0378	Raillux Mono	Grey	Grey	3800lm	3000K	>80Ra	40W	60°
2.16.0379	Raillux Mono	White	White	3800lm	3000K	>80Ra	40W	60°
2.16.0380	Raillux Mono	Black	Grey	3800lm	3000K	>80Ra	40W	60°
2.16.0381	Raillux Mono	Grey	Grey	3910lm	4000K	>80Ra	40W	60°
2.16.0382	Raillux Mono	White	White	3910lm	4000K	>80Ra	40W	60°
2.16.0383	Raillux Mono	Black	Grey	3910lm	4000K	>80Ra	40W	60°

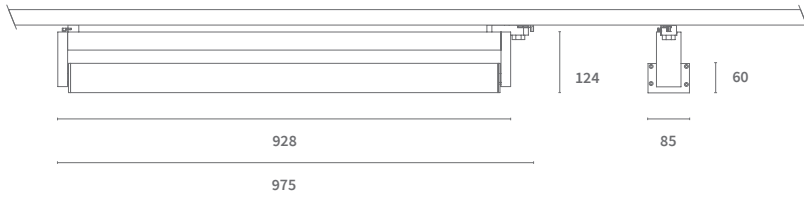

ALSO AVAILABLE

Article No.	Description
See page 186	3-Phase Tracks and accessories

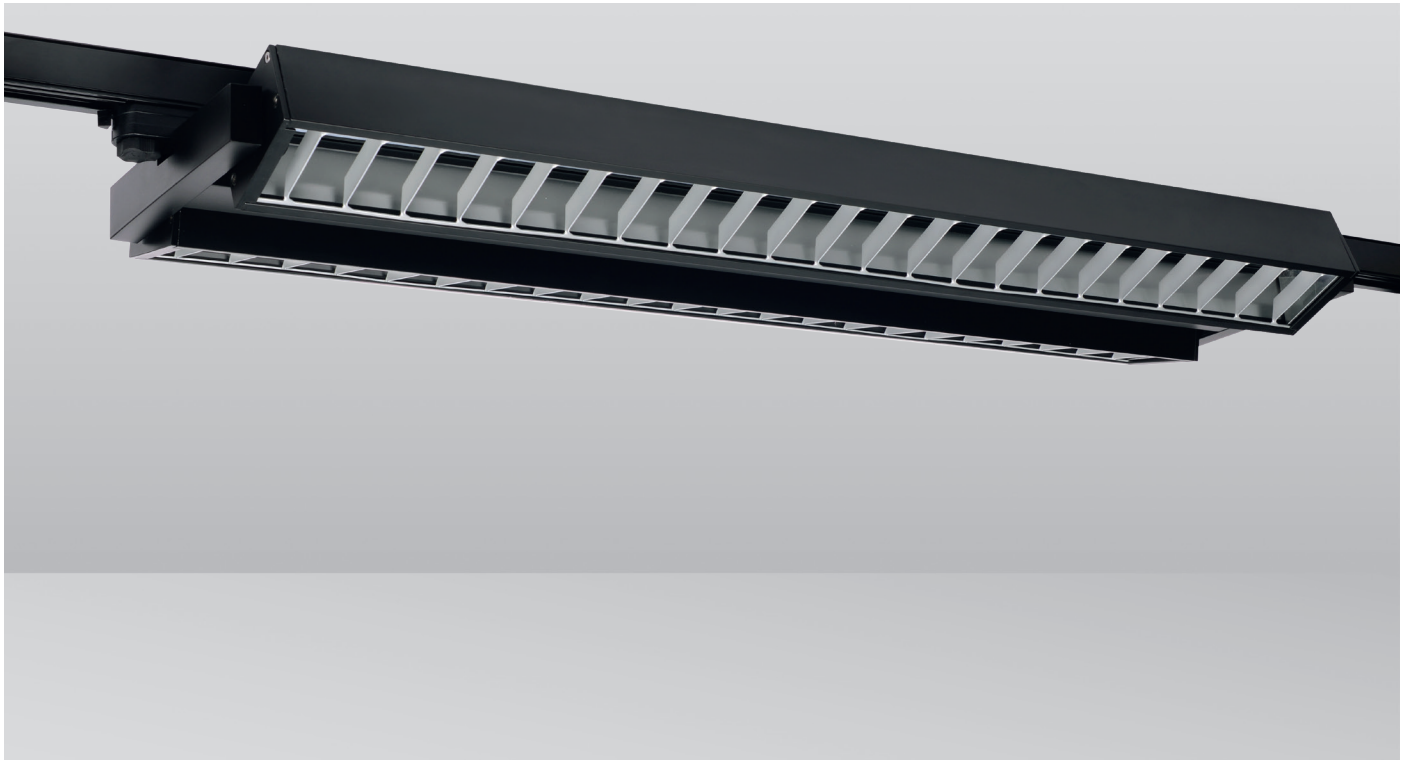

Raillux Duo

3-Phase Track Light

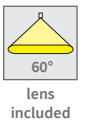

UGR	UGR <19	
System Power	80W	
CRI	>80Ra	
CCT	3000K	4000K
System Lumen	7600lm	7820lm
System Efficacy	95lm/W	97lm/W
LOR	Up to 80%	
Driver	Non-Dimmable Driver (included)	

Raillux Mono 40W 3000K (per side)

H [m]	[lux]	Beam [Ø cm]
1	2481	160
2	620	320
3	276	480
4	155	630
5	99	790

Beam (50%) Angle: 77°

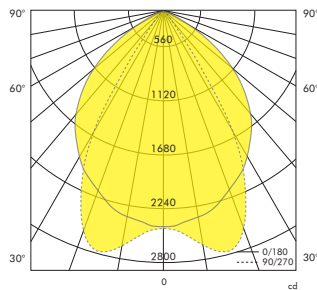

PRODUCT LIST

Article No.	Product Name	Housing Color	Louvre Color	System Lumen	CCT	CRI	System Power	Lens
2.16.0384	Raillux Duo	Grey	Grey	7600lm	3000K	>80Ra	72W	60°
2.16.0385	Raillux Duo	White	White	7600lm	3000K	>80Ra	72W	60°
2.16.0386	Raillux Duo	Black	Grey	7600lm	3000K	>80Ra	72W	60°
2.16.0387	Raillux Duo	Grey	Grey	7820lm	4000K	>80Ra	72W	60°
2.16.0388	Raillux Duo	White	White	7820lm	4000K	>80Ra	72W	60°
2.16.0389	Raillux Duo	Black	Grey	7820lm	4000K	>80Ra	72W	60°

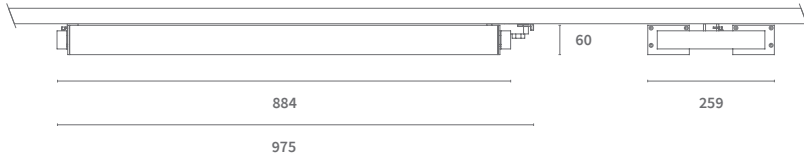

ALSO AVAILABLE

Article No.	Description
See page 186	3-Phase Tracks and accessories

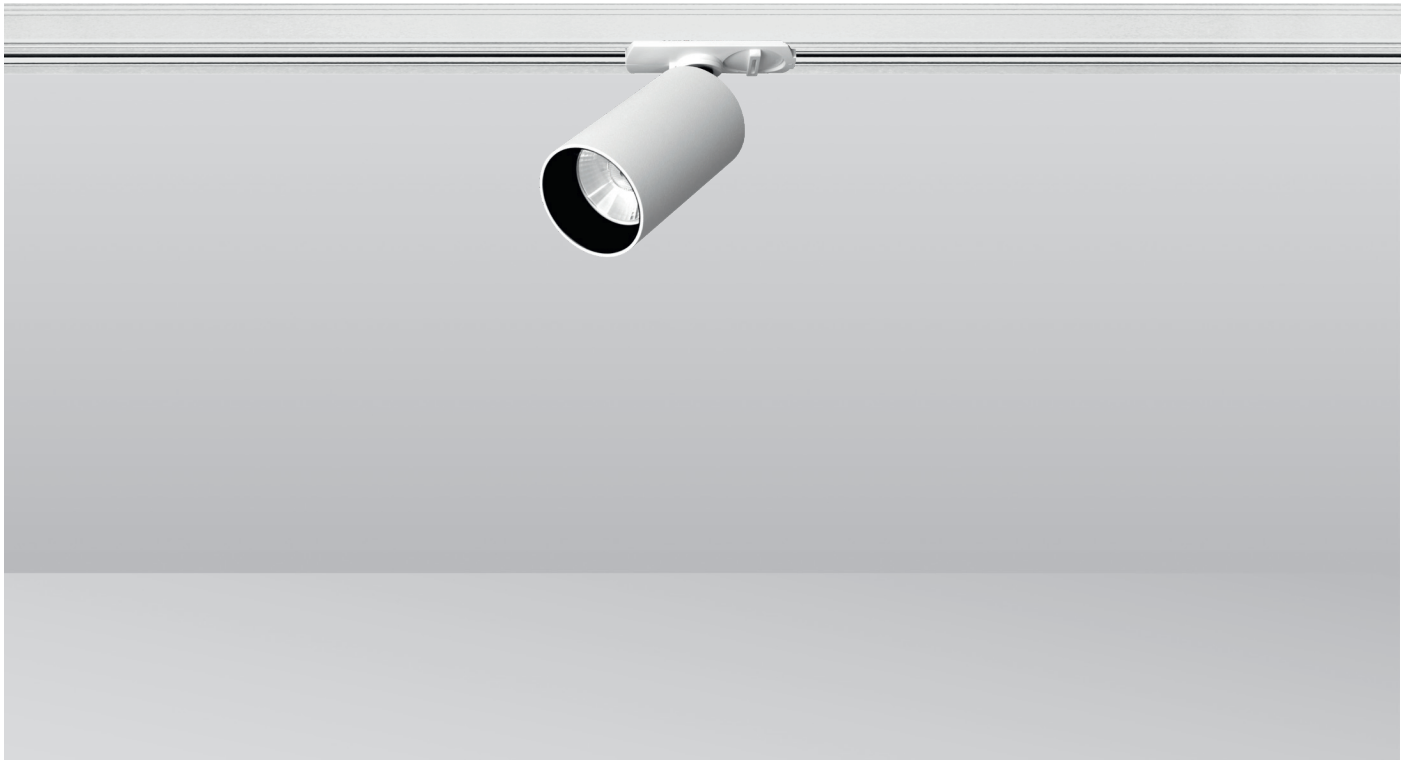

Galex II

1-Phase Track Light

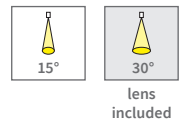

LED Power	7.6W (230V)*	
CRI	>90Ra	
CCT	2700K	3000K
LED Lumen	544lm	560lm
LED Efficacy	up tp 73lm/W	
LOR	>90%	
Driver	Dimmable 230V LED	
Dimmable with	Leading / Trailing edge dimmer	

* Due to the 230V frequency of 50Hz, some people may experience discomfort caused by the strobe effect of the light.

Galex II 7.6W 3000K

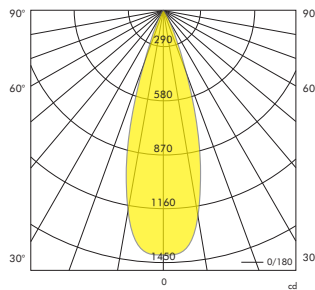
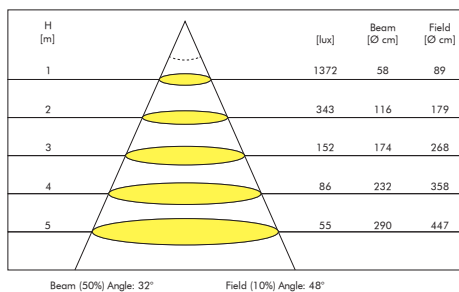

PRODUCT LIST

Article No.	Product Name	Color	LED Lumen	CCT	CRI	LED Power	Lens
2.16.0427	Galex II 1-Phase Rail	White	544lm	2700K	>90Ra	7.6W	30°
2.16.0428	Galex II 1-Phase Rail	White	560lm	3000K	>90Ra	7.6W	30°
2.16.0430	Galex II 1-Phase Rail	Black	544lm	2700K	>90Ra	7.6W	30°
2.16.0431	Galex II 1-Phase Rail	Black	560lm	3000K	>90Ra	7.6W	30°

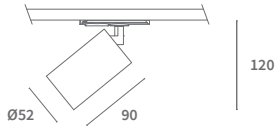
**ALSO AVAILABLE**

Article No.	Description
See page 190	1-Phase Track and accessories
2.01.1015	Lens 15° for Galex II



Common II

1-Phase Track Light

*GZ10 / MR16



* Compatible with most MR16 LED Bulbs with GZ10 / GU10 lamp base.

Power	Max. 50W
Input Voltage	230V
Lamp Holder	GZ10 (included)
Lamp Type	MR16 (50mm)
Adapter	1-Phase (included)

* Photometric information is determined by the chosen light source.

PRODUCT LIST

Article No.	Product Name	Color	Lamp Type	Lamp Holder	Voltage	Power
2.16.0327	Common II	Silver Grey	MR16 (50mm)	GZ10	230V	Max. 50W
2.16.0328	Common II	White	MR16 (50mm)	GZ10	230V	Max. 50W

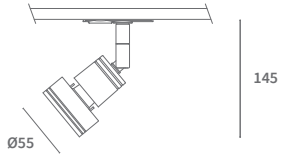
**ALSO AVAILABLE**

Article No.	Description
See page 190	1-Phase Track and accessories



Telescope II

1-Phase Track Light

*GZ10 / MR16



* Compatible with most MR16 LED Bulbs with GZ10 / GU10 lamp base.

Power	Max. 50W
Input Voltage	230V
Lamp Holder	GZ10 (included)
Lamp Type	MR16 (50mm)
Adapter	1-Phase (included)

* Photometric information is determined by the chosen light source.

PRODUCT LIST

Article No.	Product Name	Color	Lamp Type	Lamp Holder	Voltage	Power
2.16.0325	Telescope II	Silver Grey	MR16 (50mm)	GZ10	230V	Max. 50W
2.16.0326	Telescope II	White	MR16 (50mm)	GZ10	230V	Max. 50W
2.16.0423	Telescope II	Black	MR16 (50mm)	GZ10	230V	Max. 50W

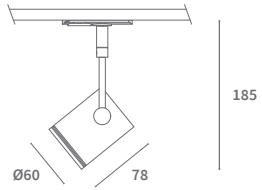
**ALSO AVAILABLE**

Article No.	Description
See page 190	1-Phase Track and accessories

Track System

3-Phase

Voltage	230V
Current	16A

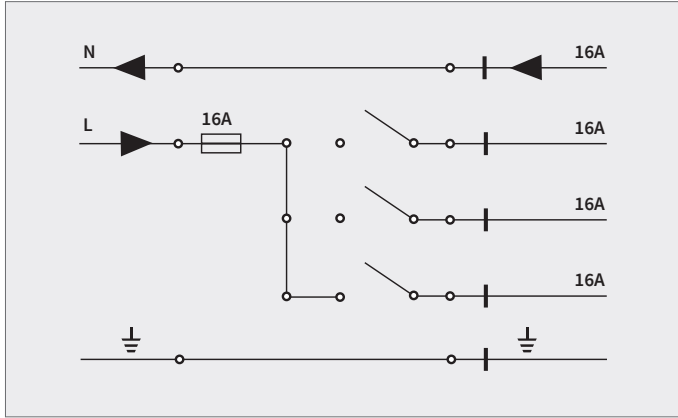

Single Phase Connection (230V)

This allows a total load of 16A, corresponding to 3680W, which can be divided among the 3 circuits.

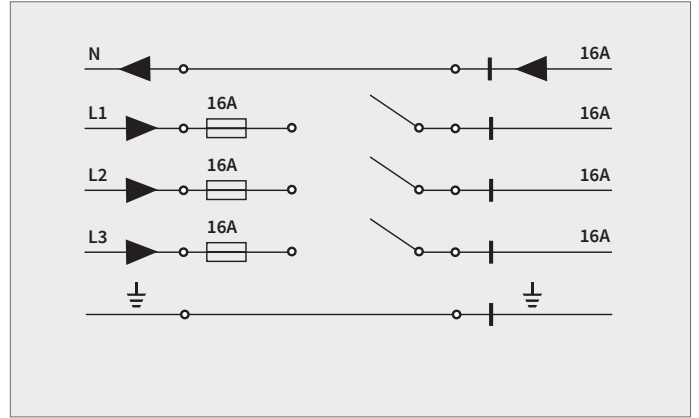

Three Phase Connection (230V)

This allows a total load of 3 x 16A, corresponding to 11040W, which can be divided among the 3 circuits, 3 x 3680W.

To install a three-phase track there is a wide range of parts available.

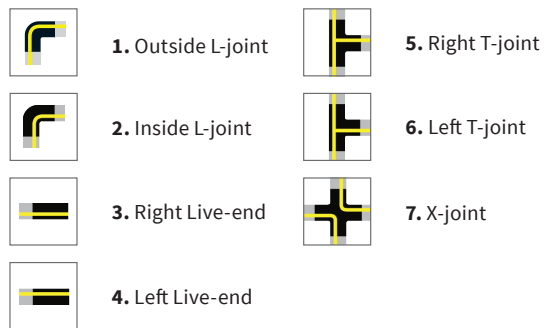
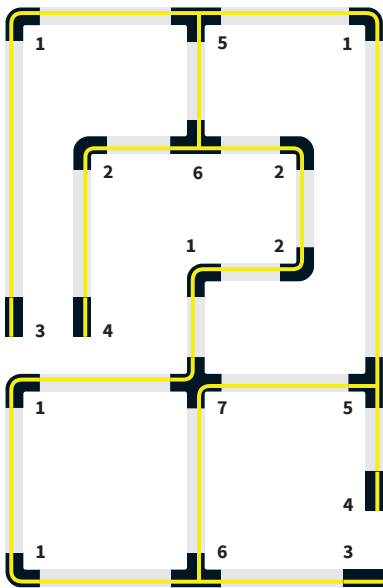

Live-end with earth on the left **L**

Live-end with earth on the right **R**

Load Capacity

The three phase tracks can take a 2 KG load every 200mm, with a maximum distance of 800mm between the fixing points.

For a 5 KG load every 200mm, the maximum fixing distance has to be 400mm.

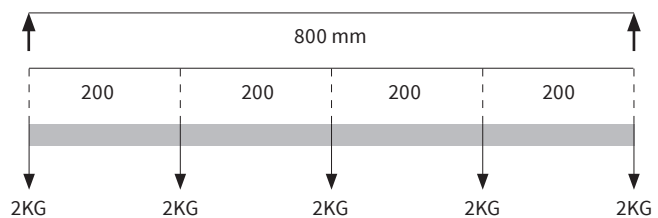

Track System

1-Phase

Voltage	230V
Current	Max. 16A

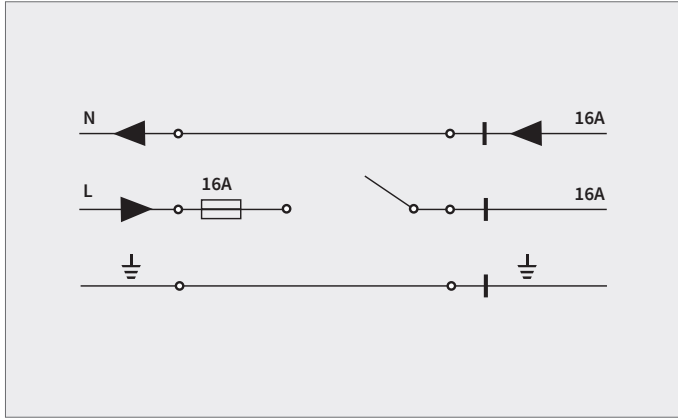

Single Phase Connection (230V)

This allows a total load of 16A, corresponding to 3680W.

To install a 1-Phase track there is a wide range of parts available.

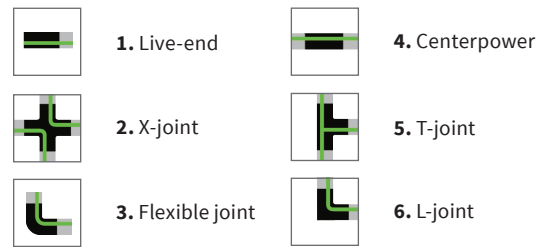
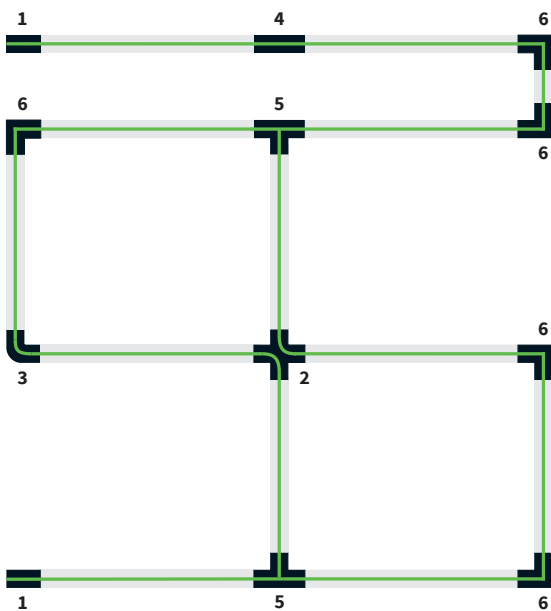

Load Capacity

The one phase tracks can take a 1 KG load every 250mm, with a maximum distance of 1000mm between the fixing points.

For a 4 KG load every 250mm, the maximum fixing distance has to be 500mm.

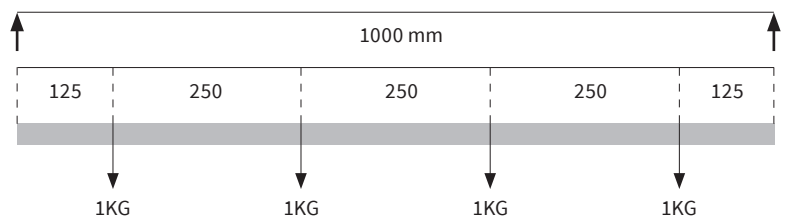



Track System

3-Phase
Square

Voltage	230V
Current	16A

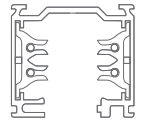

33

36

PRODUCT LIST						
Article No.	Product Name	Color		Voltage	Current	Length
8.04.1554	3-Phase Track Square	Aluminium	●	230V / 440V	16A	1 Meter
8.04.1553	3-Phase Track Square	White	○	230V / 440V	16A	1 Meter
8.04.1552	3-Phase Track Square	Black	●	230V / 440V	16A	1 Meter
8.04.1557	3-Phase Track Square	Aluminium	●	230V / 440V	16A	2 Meter
8.04.1556	3-Phase Track Square	White	○	230V / 440V	16A	2 Meter
8.04.1555	3-Phase Track Square	Black	●	230V / 440V	16A	2 Meter
8.04.1560	3-Phase Track Square	Aluminium	●	230V / 440V	16A	3 Meter
8.04.1559	3-Phase Track Square	White	○	230V / 440V	16A	3 Meter
8.04.1558	3-Phase Track Square	Black	●	230V / 440V	16A	3 Meter
8.04.2443	3-Phase Track Square	Aluminium	●	230V / 440V	16A	4 Meter
8.04.2442	3-Phase Track Square	White	○	230V / 440V	16A	4 Meter
8.04.2441	3-Phase Track Square	Black	●	230V / 440V	16A	4 Meter

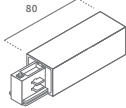
	LIVE-END		
	8.04.2418	Live-end (right)	<input type="radio"/>
	8.04.1613	Live-end (right)	<input type="radio"/>
	8.04.1612	Live-end (right)	<input checked="" type="radio"/>
	8.04.2419	Live-end (left)	<input type="radio"/>
	8.04.1615	Live-end (left)	<input type="radio"/>
	8.04.1614	Live-end (left)	<input checked="" type="radio"/>

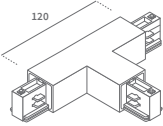
	T-JOINT		
	8.04.2423	T-joint (right)	<input type="radio"/>
	8.04.1625	T-joint (right)	<input type="radio"/>
	8.04.1624	T-joint (right)	<input checked="" type="radio"/>
	8.04.2424	T-joint (left)	<input type="radio"/>
	8.04.1627	T-joint (left)	<input type="radio"/>
	8.04.1626	T-joint (left)	<input checked="" type="radio"/>

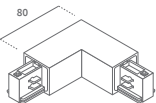
	L-JOINT		
	8.04.2421	L-joint (inside)	<input type="radio"/>
	8.04.1621	L-joint (inside)	<input type="radio"/>
	8.04.1620	L-joint (inside)	<input checked="" type="radio"/>
	8.04.2422	L-joint (outside)	<input type="radio"/>
	8.04.1623	L-joint (outside)	<input type="radio"/>
	8.04.1622	L-joint (outside)	<input checked="" type="radio"/>

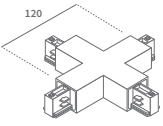
	X-joint		
	8.04.2425	X-joint	<input type="radio"/>
	8.04.1629	X-joint	<input type="radio"/>
	8.04.1628	X-joint	<input checked="" type="radio"/>

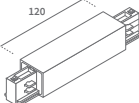
	CENTRAL CONNECTOR		
	8.04.2421	Central connector	<input type="radio"/>
	8.04.1617	Central connector	<input type="radio"/>
	8.04.1617	Central connector	<input checked="" type="radio"/>

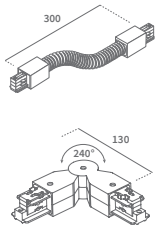
	FLEXIBLE JOINT		
	8.04.2426	Flexible joint	<input type="radio"/>
	8.04.1631	Flexible joint	<input type="radio"/>
	8.04.1630	Flexible joint	<input checked="" type="radio"/>
	8.04.4075	Flexible joint	<input type="radio"/>
	8.04.4076	Flexible joint	<input type="radio"/>
	8.04.4077	Flexible joint	<input checked="" type="radio"/>

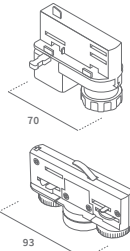
	UNIVERSAL ADAPTOR		
	8.04.2407	Universal adaptor	<input type="radio"/>
	8.04.1571	Universal adaptor	<input type="radio"/>
	8.04.1570	Universal adaptor	<input checked="" type="radio"/>
	8.04.3529	Universal adaptor	<input type="radio"/>
	8.04.3531	Universal adaptor	<input type="radio"/>
	8.04.3530	Universal adaptor	<input checked="" type="radio"/>

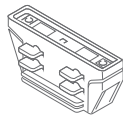
	ELECTRICAL / MECHANICAL JOINT		
	8.04.1579	Electrical straight joint	<input type="radio"/>
	8.04.1578	Electrical straight joint	<input checked="" type="radio"/>
	8.04.1619	Mechanical straight joint	<input type="radio"/>
	8.04.1618	Mechanical straight joint	<input checked="" type="radio"/>

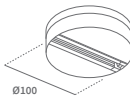
	MONOPOINT		
	1.05.0300	Monopoint	<input type="radio"/>
	1.05.0242	Monopoint	<input type="radio"/>
	1.05.0241	Monopoint	<input checked="" type="radio"/>

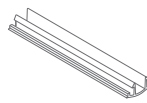
	TRACK COVER		
	8.04.1603	Track cover 1m	<input type="radio"/>
	8.04.1602	Track cover 1m	<input checked="" type="radio"/>

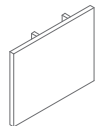
	END CAP		
	8.04.2427	End cap	<input type="radio"/>
	8.04.1633	End cap	<input type="radio"/>
	8.04.1632	End cap	<input checked="" type="radio"/>

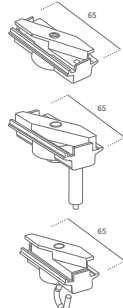
	MECHANICAL ADAPTOR		
	8.04.1605	Mechanical adaptor	<input type="radio"/>
	8.04.1604	Mechanical adaptor	<input checked="" type="radio"/>
	8.04.4078	Mechanical adaptor with cable blocker	<input type="radio"/>
	8.04.4079	Mechanical adaptor with cable blocker	<input checked="" type="radio"/>
	8.04.4080	Mechanical adaptor with hook	<input type="radio"/>
	8.04.4081	Mechanical adaptor with hook	<input type="radio"/>
8.04.4082	Mechanical adaptor with hook	<input checked="" type="radio"/>	

	MOUNTING BRACKET		
	8.04.1589	Mounting bracket	<input type="radio"/>

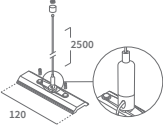
	SUSPENSION KIT (WIRE LENGTH 2.5M)		
	1.01.0210	Suspension kit	<input type="radio"/>
		(120mm plate, cable blocker and fixed ceiling mount)	

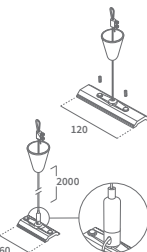
	SUSPENSION KIT (WIRE LENGTH 2M)		
	8.04.1588	Suspension kit (120mm plate)	<input type="radio"/>
	8.04.1587	Suspension kit (120mm plate)	<input checked="" type="radio"/>
	8.04.2675	Suspension kit (60mm plate and cable blocker)	<input type="radio"/>
	8.04.2676	Suspension kit (60mm plate and cable blocker)	<input checked="" type="radio"/>

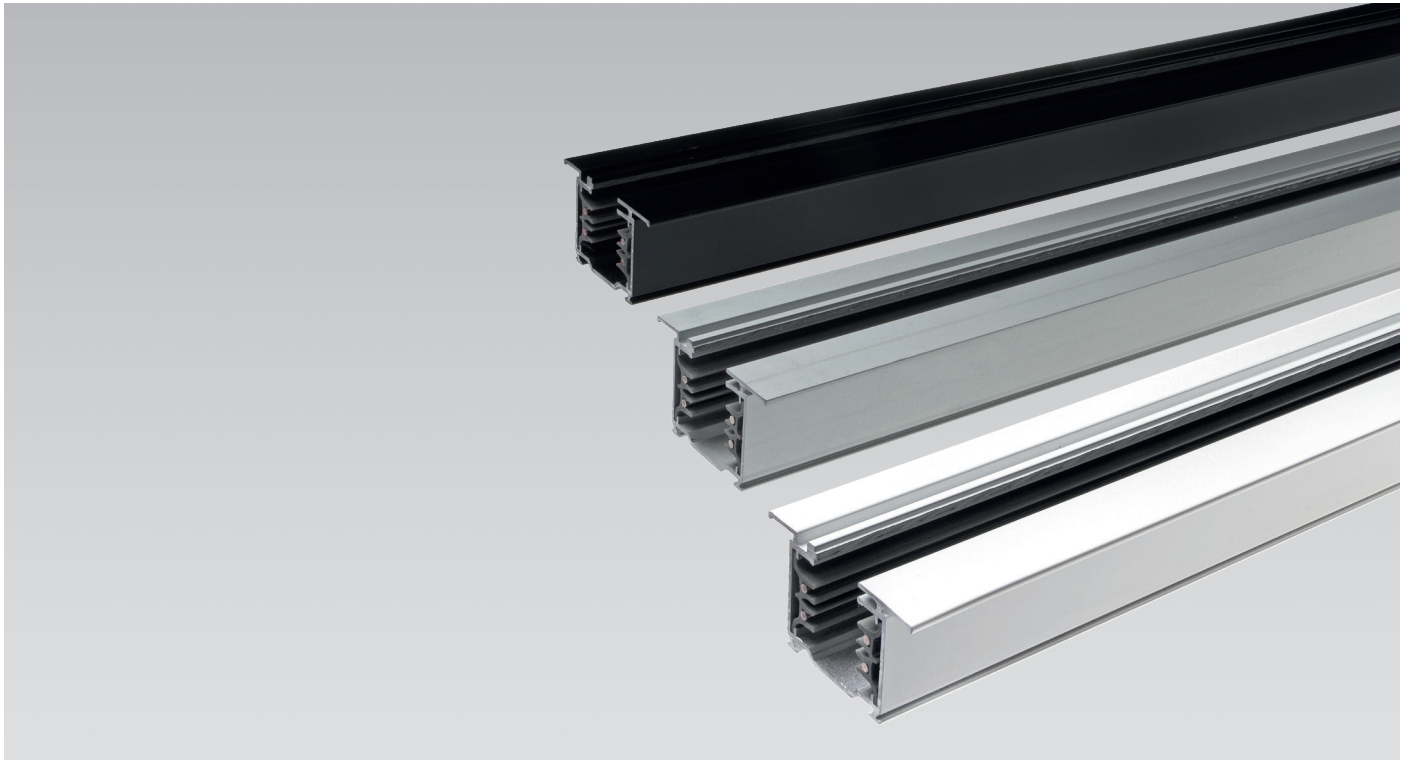

Track System

3-Phase
Recessed Square

Voltage	230V
Current	16A

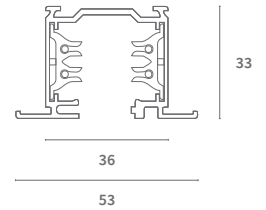

PRODUCT LIST						
Article No.	Product Name	Color		Voltage	Current	Length
8.04.1563	3-Phase Track Recessed Square	Aluminium	●	230V / 440V	16A	1 Meter
8.04.1562	3-Phase Track Recessed Square	White	○	230V / 440V	16A	1 Meter
8.04.1561	3-Phase Track Recessed Square	Black	●	230V / 440V	16A	1 Meter
8.04.1566	3-Phase Track Recessed Square	Aluminium	●	230V / 440V	16A	2 Meter
8.04.1565	3-Phase Track Recessed Square	White	○	230V / 440V	16A	2 Meter
8.04.1564	3-Phase Track Recessed Square	Black	●	230V / 440V	16A	2 Meter
8.04.1569	3-Phase Track Recessed Square	Aluminium	●	230V / 440V	16A	3 Meter
8.04.1568	3-Phase Track Recessed Square	White	○	230V / 440V	16A	3 Meter
8.04.1567	3-Phase Track Recessed Square	Black	●	230V / 440V	16A	3 Meter
8.04.2446	3-Phase Track Recessed Square	Aluminium	●	230V / 440V	16A	4 Meter
8.04.2445	3-Phase Track Recessed Square	White	○	230V / 440V	16A	4 Meter
8.04.2444	3-Phase Track Recessed Square	Black	●	230V / 440V	16A	4 Meter

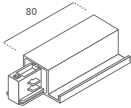
	LIVE-END		
	8.04.2428	Live-end (right)	●
	8.04.1635	Live-end (right)	○
	8.04.1634	Live-end (right)	●
	8.04.2429	Live-end (left)	●
	8.04.1637	Live-end (left)	○
	8.04.1636	Live-end (left)	●

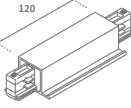
	CENTRAL CONNECTOR		
	8.04.2430	Central connector	●
	8.04.1639	Central connector	○
8.04.1638	Central connector	●	

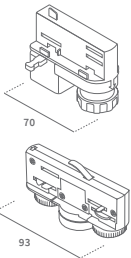
	UNIVERSAL ADAPTOR		
	8.04.2407	Universal adaptor	●
	8.04.1571	Universal adaptor	○
	8.04.1570	Universal adaptor	●
	8.04.3529	Universal adaptor	●
	8.04.3531	Universal adaptor	○
8.04.3530	Universal adaptor	●	

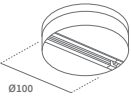
	MONOPOINT		
	1.05.0300	Monopoint	●
	1.05.0242	Monopoint	○
1.05.0241	Monopoint	●	

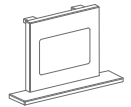
	END CAP		
	8.04.4102	End cap	●
	8.04.4103	End cap	○
8.04.4104	End cap	●	

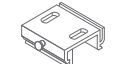
	MOUNTING BRACKET		
	8.04.1589	Mounting bracket	●

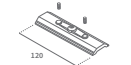
	STRENGTHENING PLATE 120MM		
	8.04.1586	Strengthening plate 120mm	●

	SUSPENSION PART		
	8.04.1640	Suspension for false ceiling	●

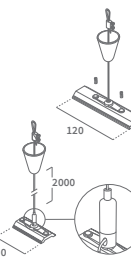
	SUSPENSION KIT (WIRE LENGTH 2M)		
	8.04.1588	Suspension kit (120mm plate)	○
	8.04.1587	Suspension kit (120mm plate)	●
	8.04.2675	Suspension kit (60mm plate and cable blocker)	○
	8.04.2676	Suspension kit (60mm plate and cable blocker)	●

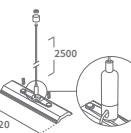
	SUSPENSION KIT (WIRE LENGTH 2.5M)		
	1.01.0210	Suspension kit (120mm plate, cable blocker and fixed ceiling mount)	●

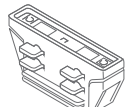
	ELECTRICAL / MECHANICAL JOINT		
	8.04.1579	Electrical straight joint	○
	8.04.1578	Electrical straight joint	●
	8.04.1619	Mechanical straight joint	○
	8.04.1618	Mechanical straight joint	●

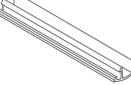
	TRACK COVER		
	8.04.1603	Track cover 1m	○
	8.04.1602	Track cover 1m	●

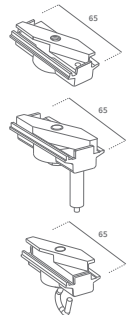
	MECHANICAL ADAPTOR		
	8.04.1605	Mechanical adaptor	○
	8.04.1604	Mechanical adaptor	●
	8.04.4078	Mechanical adaptor with cable blocker	○
	8.04.4079	Mechanical adaptor with cable blocker	●
	8.04.4080	Mechanical adaptor with hook	●
8.04.4081	Mechanical adaptor with hook	○	
8.04.4082	Mechanical adaptor with hook	●	

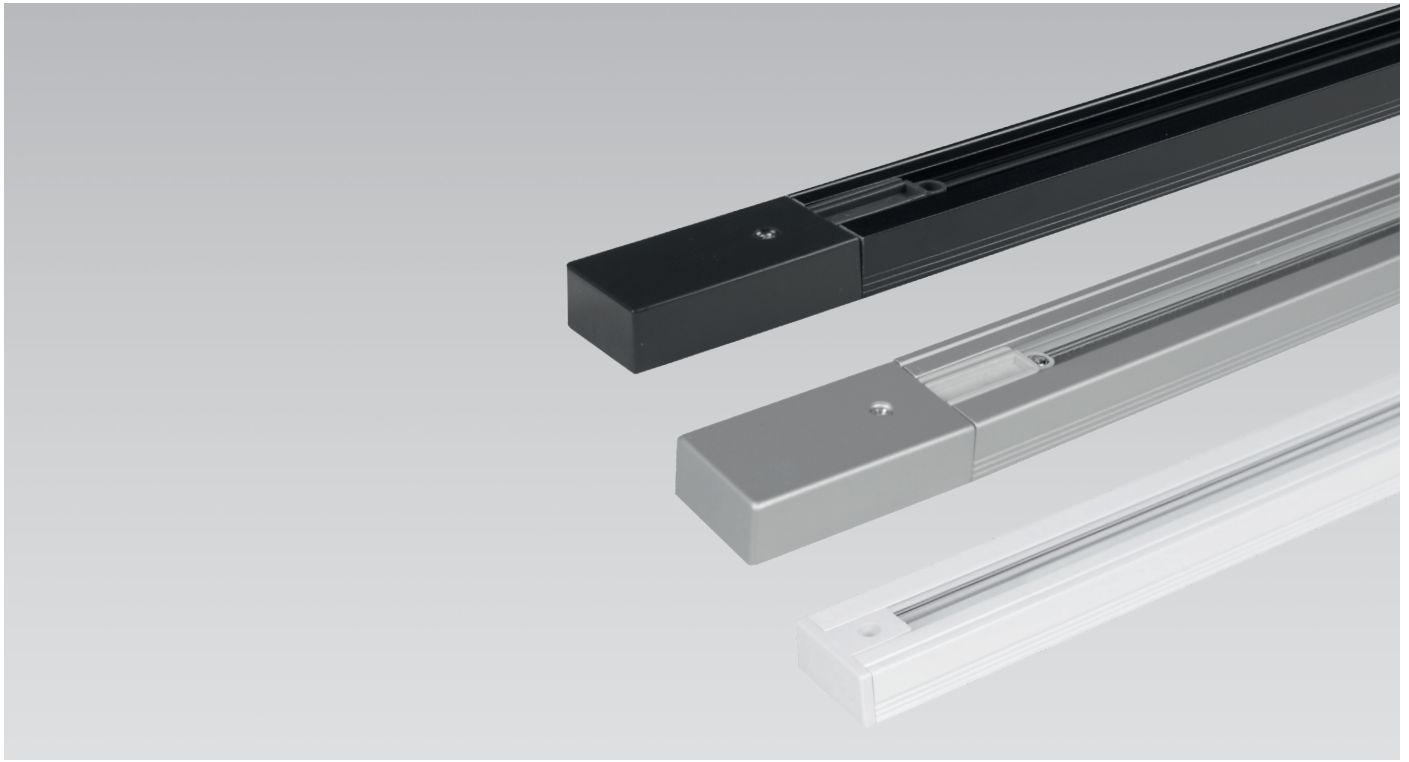

Track System

1-Phase
Square

Voltage	230V
Current	16A

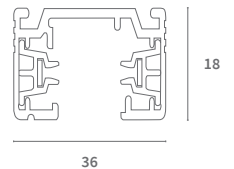

PRODUCT LIST							
Article No.	Product Name	Color		Voltage	Current	Length	Included
1.02.0001	1-Phase Track Square	Aluminium	●	230V / 250V	16A	1 Meter	Live-end (left) + End cap
1.02.0005	1-Phase Track Square	White	○	230V / 250V	16A	1 Meter	Live-end (left) + End cap
1.02.0013	1-Phase Track Square	Black	●	230V / 250V	16A	1 Meter	Live-end (left) + End cap
1.02.0002	1-Phase Track Square	Aluminium	●	230V / 250V	16A	2 Meter	Live-end (left) + End cap
1.02.0006	1-Phase Track Square	White	○	230V / 250V	16A	2 Meter	Live-end (left) + End cap
1.02.0014	1-Phase Track Square	Black	●	230V / 250V	16A	2 Meter	Live-end (left) + End cap
1.02.0003	1-Phase Track Square	Aluminium	●	230V / 250V	16A	3 Meter	Live-end (left) + End cap
1.02.0007	1-Phase Track Square	White	○	230V / 250V	16A	3 Meter	Live-end (left) + End cap
1.02.0015	1-Phase Track Square	Black	●	230V / 250V	16A	3 Meter	Live-end (left) + End cap

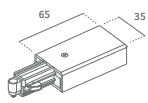
	LIVE-END		
	1.01.0095	Live-end (right)	<input checked="" type="radio"/>
	1.01.0112	Live-end (right)	<input type="radio"/>
	1.01.0200	Live-end (right)	<input checked="" type="radio"/>
	1.01.0094	Live-end (left)	<input checked="" type="radio"/>
	1.01.0111	Live-end (left)	<input type="radio"/>

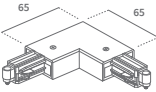
	L-JOINT		
	1.01.0099	L-joint (inside)	<input checked="" type="radio"/>
	1.01.0116	L-joint (inside)	<input type="radio"/>
	1.01.0204	L-joint (inside)	<input checked="" type="radio"/>
	1.01.0098	L-joint (outside)	<input checked="" type="radio"/>
	1.01.0115	L-joint (outside)	<input type="radio"/>
	1.01.0203	L-joint (outside)	<input checked="" type="radio"/>

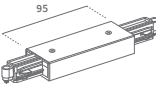
	CENTRAL CONNECTOR		
	1.01.0104	Central connector	<input checked="" type="radio"/>
	1.01.0121	Central connector	<input type="radio"/>
	1.01.0207	Central connector	<input checked="" type="radio"/>

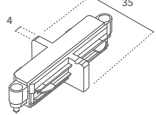
	ELECTRICAL JOINT		
	1.01.0102	Electrical straight joint	<input checked="" type="radio"/>
	1.01.0119	Electrical straight joint	<input type="radio"/>
	1.01.0206	Electrical straight joint	<input checked="" type="radio"/>

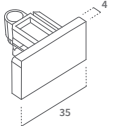
	END CAP		
	1.01.0101	End cap	<input checked="" type="radio"/>
	1.01.0118	End cap	<input type="radio"/>
	1.01.0205	End cap	<input checked="" type="radio"/>

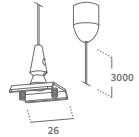
	SUSPENSION KIT (WIRE LENGTH 3M)		
	1.01.0107	Suspension kit	<input checked="" type="radio"/>
	1.01.0124	Suspension kit	<input type="radio"/>
	1.01.0209	Suspension kit	<input checked="" type="radio"/>

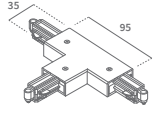
	T-JOINT		
	1.01.0106	T-joint (right)	<input checked="" type="radio"/>
	1.01.0123	T-joint (right)	<input type="radio"/>
	1.01.0208	T-joint (right)	<input checked="" type="radio"/>
	1.01.0105	T-joint (left)	<input checked="" type="radio"/>
	1.01.0122	T-joint (left)	<input type="radio"/>

	X-JOINT		
	1.01.0103	X-joint	<input checked="" type="radio"/>
	1.01.0120	X-joint	<input type="radio"/>

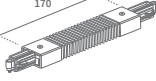
	FLEXIBLE JOINT		
	1.01.0100	Flexible joint	<input checked="" type="radio"/>
	1.01.0117	Flexible joint	<input type="radio"/>

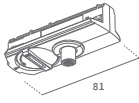
	UNIVERSAL ADAPTOR INSIDE M10		
	1.01.0096	Universal adaptor	<input checked="" type="radio"/>
	1.01.0113	Universal adaptor	<input type="radio"/>
	1.01.0201	Universal adaptor	<input checked="" type="radio"/>

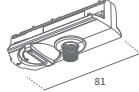
	UNIVERSAL ADAPTOR OUTSIDE M10		
	1.01.0097	Universal adaptor	<input checked="" type="radio"/>
	1.01.0114	Universal adaptor	<input type="radio"/>
	1.01.0202	Universal adaptor	<input checked="" type="radio"/>

Lumiparts

Nijverheidsweg 2
2421 LR Nieuwkoop
The Netherlands
+31 (0)172 574 500
info@lumiparts.com
www.lumiparts.com